







User 's Manual





























































EN





































Power monitoring devices MC3x0x series:

- *Multimeter – MC330*
- *Network Recorder – MC350 & MC350H*

TABLE OF CONTENTS

SECURITY ADVICE AND WARNINGS	1
WARNINGS, INFORMATION AND NOTES REGARDING DESIGNATION OF THE PRODUCT	2
<i>Contents of consignment</i>	2
BEFORE SWITCHING THE DEVICE ON	3
DEVICE SWITCH OFF WARNING	4
HEALTH AND SAFETY	5
REAL TIME CLOCK	6
DISPOSAL	7
BASIC DESCRIPTION AND OPERATION	8
INTRODUCTION.....	8
<i>Description of symbols</i>	8
GLOSSARY	9
DESCRIPTION OF THE PRODUCT	10
<i>Appearance</i>	10
PURPOSE AND USE OF DIFFERENT TYPES OF MEASURING CENTERS	10
<i>Multifunction meter MC330</i>	10
<i>Network Recorder MC350 & MC350H</i>	10
TYPE DIFFERENCES	11
<i>Differences in hardware</i>	11
<i>Software functions</i>	11
<i>Supported measurements</i>	12
CONNECTION	13
INTRODUCTION.....	13
MOUNTING	14
ELECTRIC CONNECTION	15
CONNECTION OF INPUT/OUTPUT MODULES.....	16
COMMUNICATION CONNECTION	17
RS232	17
RS485	17
M-Bus (MC350 and MC350H only).....	17
USB.....	17
Service USB (MC330 only)	18
Survey of communication connection	19
CONNECTION OF POWER SUPPLY	19
FIRST STEPS	20
INTRODUCTION.....	20
<i>Basic concepts</i> 	20
<i>Installation wizard</i> 	21
DISPLAY OF DEVICE INFO.....	22
<i>Welcome screen</i> 	22
<i>Information</i>  	22
<i>Meaning of icons</i> 	22
SETTINGS	23
INTRODUCTION.....	23

MIQEN SOFTWARE	23
<i>Devices management</i>	23
<i>Device settings</i>	23
<i>Real-time measurements</i>	24
<i>Data analysis</i>	24
<i>Software upgrading</i>	25
SETTING PROCEDURE	25
GENERAL SETTINGS	26
<i>Description and Location</i> 	26
<i>Average interval</i>  	26
<i>Language</i>  	26
<i>Temperature unit</i>  	26
<i>Date format (MC350 and MC350H only)</i>  	26
<i>Date and time (MC350 and MC350H only)</i>  	26
<i>Auto Summer/Winter time (MC350 and MC350H only)</i>  	26
<i>Maximum demand (MD) time constant</i>  	27
<i>Starting current for PF and PA (mA)</i> 	27
<i>Starting current for all powers (mA)</i> 	27
<i>Starting voltage for all powers</i> 	27
<i>Starting voltage for SYNC</i> 	27
<i>Reactive power and energy calculation</i> 	28
CONNECTION	28
<i>Connection</i>  	28
<i>Setting of current and voltage ratios</i>  	28
<i>Used voltage and current range</i> 	28
<i>Nominal frequency</i> 	28
<i>Wrong connection warning</i> 	29
<i>Energy flow direction</i> 	29
<i>CT connection</i> 	29
COMMUNICATION.....	29
<i>Serial Communication</i>  	29
<i>USB Communication</i> 	29
<i>Service USB Communication (MC330 only)</i> 	29
<i>M-Bus Communication</i> 	29
DISPLAY	30
<i>Display settings</i>  	30
<i>Demo cycling period</i>  	30
<i>Settings of customized screens</i>  	30
SECURITY	31
<i>Password setting</i>  	31
<i>Password modification</i>  	31
<i>Password disabling</i>  	31
<i>Password and language</i>	32
ENERGY - COUNTERS	32
<i>Active tariff</i>  	32
<i>Common Energy Exponent (Common Energy Counter Resolution – MiQen 2.x and above)</i>	32
<i>Counter divider (Individual counter Resolution – MiQen 2.x and above)</i>	33
<i>Tariff clock</i> 	33
<i>Counter measured quantity</i> 	34
INPUTS AND OUTPUTS.....	34
<i>Pulse (SO) module</i>  	35
<i>Relay (alarm) module</i>  	35
<i>Functions of output modules (Pulse and Relay)</i>  	35
<i>Digital input module</i> 	36
<i>Tariff input module</i> 	36
ALARMS.....	37
<i>Alarms setting</i> 	37
<i>Alarms setting</i> 	37

<i>Types of alarms</i>	37
MEMORY (MC350 AND MC350H ONLY)	38
<i>Memory division</i> 	38
<i>Memory operation</i>  	38
<i>Memory clearing</i> 	38
<i>Recorders A and B setting</i> 	38
RESET OPERATIONS	39
<i>Reset energy counters (E1, E2, E3, E4)</i>  	39
<i>Reset maximal MD values</i>  	39
<i>Reset the last MD period (MC350 and MC330 only)</i>  	39
<i>Alarm relay (1 or 2) Off (MC350 and MC330 only)</i>  	39
<i>Reset alarm statistic</i> 	39
MEASUREMENTS	40
INTRODUCTION	40
SUPPORTED MEASUREMENTS	40
AVAILABLE CONNECTIONS	40
<i>Survey of supported measurements regarding connection mode</i>	40
EXPLANATION OF BASIC CONCEPTS	43
<i>Sample factor – MV</i>	43
<i>Average interval – MP</i>	43
<i>Power and energy flow</i>	43
PRESENT VALUES	44
CALCULATION AND DISPLAY OF MEASUREMENTS	44
<i>Voltage</i>  	45
<i>Current</i>  	45
<i>Active, reactive and apparent power</i>  	45
<i>Power factor and power angle</i>  	45
<i>Frequency</i>  	46
<i>Energy</i>  	46
<i>MD values</i>  	46
<i>THD - Total harmonic distortion</i>  	46
<i>Customized screens</i>  	46
<i>Overview</i>  	46
ALARMS	48
<i>Survey of alarms</i>  	48
DEMONSTRATION MEASUREMENTS	48
<i>Demo cycling</i> 	48
TECHNICAL DATA	49
ACCURACY	49
INPUTS	50
<i>Voltage input</i>	50
<i>Current input</i>	50
<i>Frequency</i>	50
<i>Supply</i>	50
CONNECTION	50
<i>Permitted conductor cross-sections</i>	50
MODULES	51
<i>Relay output</i>	51
<i>S0 (pulse) output</i>	51
<i>Tariff input module</i>	51
<i>Digital input module</i>	51
<i>Analogue output</i>	51
COMMUNICATION	52
ELECTRONIC FEATURES	52
<i>LCD</i>	52
<i>Response time</i>	52
<i>Memory (MC350 & MC350H only)</i>	52

LED's.....	52
RTC backup supply	52
SAFETY FEATURES	53
Safety	53
Test voltage.....	53
EMC.....	53
Protection.....	53
Ambient conditions	53
Enclosure.....	53
DIMENSIONS.....	54
APPENDIX A: MODBUS PROTOCOL	55
MODBUS COMMUNICATION PROTOCOL.....	55
Modbus protocol.....	55
Register table for the normalized actual measurements.....	57
100% values calculations for normalized measurements	59
Register table for the basic settings.....	59
Data types decoding	60
APPENDIX B: DNP3 COMMUNICATION PROTOCOL.....	61
DNP3 COMMUNICATION PROTOCOL	61
DNP3	61
Register table for the actual measurements.....	62
APPENDIX C: M-BUS	65
COMMUNICATION SETTINGS	65
COMMAND TELEGRAMS	65
Initialize M-Bus (SNK_NKE)	65
Select M-BUS MC350 Using Secondary Address (SND_UD)	65
Transmit Read-out Data via Primary / Secondary Address (REQ_UD2).....	65
Set Baud Rate via Primary / Secondary Address (SND_UD).....	66
Set Primary Address via Primary / Secondary Address (SND_UD)	66
Set Secondary Address via Primary / Secondary Address (SND_UD)	66
Reset, Restart M-BUS MC350 via Primary / Secondary Address (SND_UD).....	66
M-BUS TELEGRAMS	66
Total Energy counters 0,1,2,3	66
Active Tariff number.....	66
Active Power Total Pt (W)	67
Reactive Power Total (kvar)	67
Instant Apparent Power Total (VA)	67
Power Factor: -: leading et +: lagging: PF	67
Current Total (A).....	67
System frequency (Hz/1000)	67
Active Power in Phase 1,2,3 (W)	67
Current in Phase 1,2,3, Neutral (A)	68
Voltages (V).....	68
APPENDIX D: CALCULATIONS & EQUATIONS	69
CALCULATIONS	69
Definitions of symbols	69
EQUATIONS	69
Voltage.....	69
Current	70
Power	70
THD.....	71

SECURITY ADVICE AND WARNINGS

Please read this chapter carefully before starting work with a Measuring centre.





This chapter deals with important information and warnings that should be considered for safe work with a Measuring centre.

This booklet contains instructions for installation and use of Measuring centres MC330, MC350 & MC350H. Installation and use of devices also includes work with dangerous currents and voltages, therefore such work shall be carried out by qualified persons. The *Iskra, d.o.o.* Company assumes no responsibility in connection with installation and use of the product. If there is any doubt regarding installation and use of the system in which the instrument is used for measuring or supervision, please contact a person who is responsible for installation of such system.



WARNINGS, INFORMATION AND NOTES REGARDING DESIGNATION OF THE PRODUCT

Used symbols on devices' housing:

	<p>See product documentation.</p>
	<p>Double insulation in compliance with the EN 61010-1 standard.</p>
	<p>Functional ground potential. Note: This symbol is also used for marking a terminal for protective ground potential if it is used as a part of connection terminal or auxiliary supply terminals.</p>
	<p>Compliance of the product with directive 2002/96/EC, as first priority, the prevention of waste electrical and electronic equipment (WEEE), and in addition, the reuse, recycling and other forms of recovery of such wastes so as to reduce the disposal of waste. It also seeks to improve the environmental performance of all operators involved in the life cycle of electrical and electronic equipment.</p>
	<p>Compliance of the product with European CE directives.</p>

Contents of consignment

The consignment includes:

- Measuring centres MC330, MC350 and MC350H
- Quick Guide

BEFORE SWITCHING THE DEVICE ON

Check the following before switching on the device:

- Nominal voltage,
- Supply voltage,
- Nominal frequency,
- Voltage ratio and phase sequence,
- Current transformer ratio and terminals integrity,
- Protection fuse (recommended maximal external fuse size is 6 A – a type with a red dot or equivalent),
- Integrity of earth terminals (where necessary)



CAUTION

A current transformer secondary should be short circuited before connecting the meter.

DEVICE SWITCH OFF WARNING

Auxiliary supply circuits for (external) relays can include capacitors between supply and ground. In order to prevent electrical shock hazard, the capacitors should be discharged via external terminals after having completely disconnected auxiliary supply (both poles of any DC supply).

HEALTH AND SAFETY

The purpose of this chapter is to provide a user with information on safe installation and handling with the product in order to assure its correct use and continuous operation.

We expect that everyone using the product will be familiar with the contents of chapter »Security Advices and Warnings«.

If equipment is used in a manner not specified by the manufacturer, the protection provided by the equipment may be impaired.

REAL TIME CLOCK

As a backup power supply for Real time clock supercap is built in. Support time is up to 2 days (after each power supply down).

DISPOSAL

It is forbidden to deposit electrical and electronic equipment as municipal waste. The manufacturer or provider shall take waste electrical and electronic equipment free of charge. The complete procedure after lifetime should comply with the Directive EZ 2002/96/EG about restriction on the use of certain hazardous substances in electrical and electronic equipment or a corresponding Url 118/04.

BASIC DESCRIPTION AND OPERATION

INTRODUCTION.....	8
GLOSSARY	9
DESCRIPTION OF THE PRODUCT.....	10
PURPOSE AND USE OF DIFFERENT TYPES OF MEASURING CENTERS	10
TYPE DIFFERENCES	11

Introduction

Regarding the type of a Measuring centre different chapters should be considered since the types differ in functionality and design. More detailed description of device functions is given in chapter *Type differences*, pages 11. All types of measuring centres are available in DIN housing.

Description of symbols

In different chapters or tables different symbols may appear in User's Manual. According to the position of symbols, they have different meaning.

SUBCHAPTER

Symbols next to the subchapters indicate accessibility of functions described. Accessibility of functions is indicated with the following symbols:



- Function accessible via communication (MiQen software)



- Function accessible via navigation keys on the device front side

TABLES

Supported functions and measurements are listed in tables for all types. Symbols in tables indicate support of enabled functions for each type. Additionally a legend is placed below table of used symbols. Meaning of symbols is:

- - Function is supported
- × - Function is not supported
- - Symbol meaning varies and is described in the legend below the table

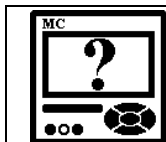

For all unknown technical words see chapter Glossary on next page.

Glossary

Term	Explanation
AC	Alternating voltage
Hand-over place	Connection spot of consumer installation in public network
Hysteresis expressed as percentage [%]	Percentage specifies increase or decrease of a measurement from a certain limit after exceeding it.
MD	Measurement of average values in time interval
MiQen	Software for <i>Iskra, d.o.o.</i> instruments
MODBUS	Industrial protocol for data transmission
M-Bus	Industrial protocol fully complies with M-BUS European standard EN13757-2
M_p – Average interval	Defines frequency of refreshing displayed measurements on the basis of a Sample factor
M_v – Sample factor	Defines a number of periods for measuring calculation on the basis of measured frequency
PA total	Angle calculated from total active and apparent power
PA1, PA2, PA3	Angle between fundamental phase voltage and phase current
PF	Power factor
TRMS	True Root Mean Square value
RMS	Root Mean Square value
RTC	Real time clock
THD	Total harmonic distortion
2SO	S0 (pulse) output module
2TI	Tariff input module
2RO	Relay (alarm) output module
2DI	Digital input module

Description of the product

A measuring centre is used for measuring, analysing and monitoring three phase electrical power network. Using the latest technologies and numerical methods we have reached high accuracy over a wide measuring range of voltage, current and integrated quantities.

Appearance

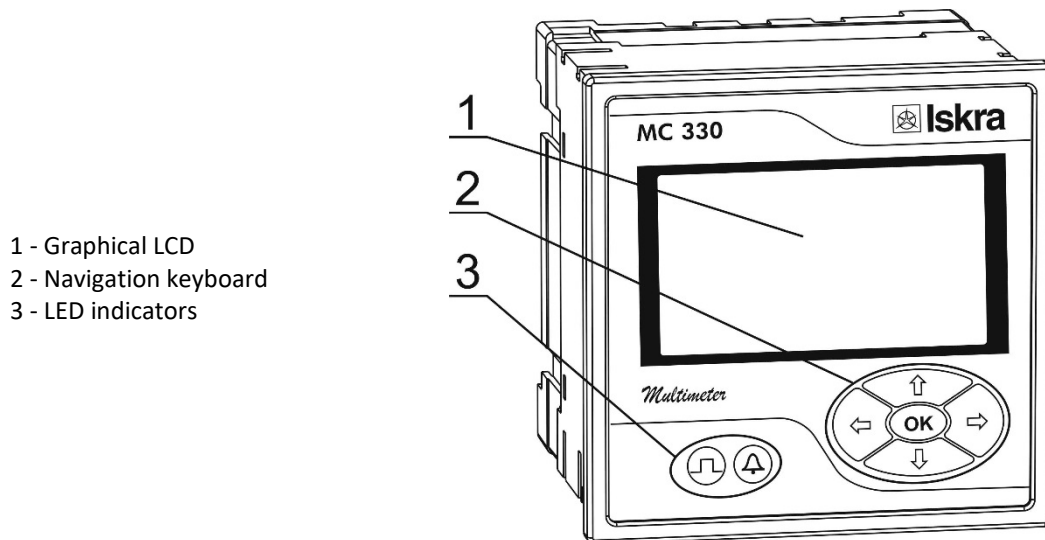

- 1 - Graphical LCD
- 2 - Navigation keyboard
- 3 - LED indicators

GRAPHICAL LCD

A graphical LCD with back light is used for high resolution of displayed measuring quantities and for a display of selected functions when setting the device.

NAVIGATION KEYBOARD

The "OK" key is used for confirming the settings, selecting and exiting the display. Direction keys are used for shifting between screens and menus.

LED INDICATORS

LED indicators warn of a certain state of the instrument. A left (red) one is blinking as pulse output. A right (red) one is blinking when the condition for the alarm is fulfilled.

Purpose and use of different types of measuring centers

Multifunction meter MC330

The instrument is used for monitoring and measuring electric quantities of three-phase electrical power distribution system. The meter is provided with 16 program adjustable alarms, Configuration can have one input, one output modules and communication module (RS232 or RS485 or USB). With the communication meter can be set and measurements can be checked. The meter also functions as an energy counter with tariffs. As an energy counter it can record energy in all four quadrants in four tariffs. Different modules that are optionally built in two module places in the meter are available for controlling measurements. Available is one input and one output module.

Network Recorder MC350 & MC350H

The instrument is used for monitoring and measuring electric quantities of electrical power system. It includes all functionality of MC330 and as addition it has 8Mb of flash memory built in. So it's additional functionality is that it measures and stores selected measured quantities and alarms in to recorder, where they are available for further analysis. At tariff clock setting, four seasons and four day groups are available. Additionally, 20 places are

available for setting holidays. As an energy counter it can record energy in all four quadrants in four tariffs. The meter could be provided with M-Bus communication module.

Type differences

Different types differ on functionality and equipment as shown in the following table.

Differences in hardware

Feature	MC330	MC350	MC350H
Graphical LCD display	●	●	●
Back light of LCD display	●	●	●
LED indicator (pulse/alarm)	●/●	●/●	●/●
Control keys on front panel (5)	●	●	●
Communication interface RS232 or RS485 or USB	○	●	●
Module 1 (2SO/2RO)	○/○	●/○	●/○
Module 2 (2TI/2DI)	○/○	●/○	●/○
Automatic voltage range	○	●	●
Automatic current range	●	●	●
AC or universal supply	●/○	○/●	○/●
Real time clock (RTC) with tariff clock	×	●	●
8MB flash memory for recorder and alarm	×	●	●

● - serial ○ - option × - not supported

Software functions

	Functions	MC330	MC350	MC350H
Basic	Setup wizard	●	●	●
	Wrong connection warning	●	●	●
	Custom screens (3)	●	●	●
	Demonstration screen cycling	●	●	●
	Programmable refresh time	●	●	●
Additional	MODBUS and DNP3 protocol	●	●	●
	MD calculation (TF)	●	●	●
	M-Bus protocol	×	●	●
	Programmable alarms (16)	●	●	●

● - serial × - not supported

Supported measurements

	Basic measurements	MC330	MC350	MC350H
Phase	Voltage U1, U2, U3 and U~	●	●	●
	Current I1, I2, I3, In, It and I~	●	●	●
	Active power P1, P2, P3, and Pt	●	●	●
	Reactive power Q1, Q2, Q3, and Qt	●	●	●
	Apparent power S1, S2, S3, and St	●	●	●
	Power factor PF1, PF2, PF3 and PF	●	●	●
	Power angle ϕ_1 , ϕ_2 , ϕ_3 and ϕ	●	●	●
	THD of phase voltage U1, U2 and U3	●	●	●
	THD of power angle I1, I2 and I3	●	●	●
Phase-to-phase	Phase-to-phase voltage U12, U23, U31	●	●	●
	Average phase-to-phase voltage Uff	●	●	●
	Phase-to-phase angle ϕ_{12} , ϕ_{23} , ϕ_{31}	●	●	●
	THD of phase-to-phase voltage	●	●	●
Energy	Counter 1	●	●	●
	Counter 2	●	●	●
	Counter 3	●	●	●
	Counter 4	●	●	●
	Total	●	●	●
	Active tariff	●	●	●

● - serial × - not supported

	Other measurements	MC330	MC350	MC350H
MD values	Phase current I1, I2, I3	●	●	●
	Active power P (Positive)	●	●	●
	Active power P (Negative)	●	●	●
	Reactive power Q – L	●	●	●
	Reactive power Q – C	●	●	●
	Apparent power S	●	●	●

● - serial (thermal function) × - not supported

	Other measurements	MC330	MC350	MC350H
	Frequency	●	●	●
	Internal temperature	●	●	●

● - serial × - not supported

CONNECTION

INTRODUCTION.....	13
MOUNTING	14
ELECTRIC CONNECTION	15
CONNECTION OF INPUT/OUTPUT MODULES.....	16
COMMUNICATION CONNECTION	17
CONNECTION OF POWER SUPPLY.....	19

Introduction

This chapter deals with the instructions for measuring centre connection. Both the use and connection of the device includes handling with dangerous currents and voltages. Connection shall therefore be performed by a qualified person. *Iskra, d.o.o.* does not take any responsibility regarding the use and connection. If any doubt occurs regarding connection and use in the system which device is intended for, please contact a person who is responsible for such installations.

Before use: Check voltages and phase rotation, supply voltage and nominal frequency.

Check protective fuse rating (the recommended maximum rating of the external protective fuse for this equipment is 6A - Red Spot type or equivalent).

WARNING!

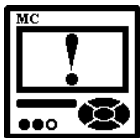

Wrong or incomplete connection of voltage or other terminals can cause non-operation or damage to the device.

PLEASE NOTE



After connection, settings have to be performed via a keyboard on the front side of the instrument that reflect connection of device to voltage network (connection mode, current and voltage transformers ratio, ...).

Mounting

- 1 Before inserting device into the panel cut out, remove four screws, insert device and position the screws correctly. Fix device to the panel.

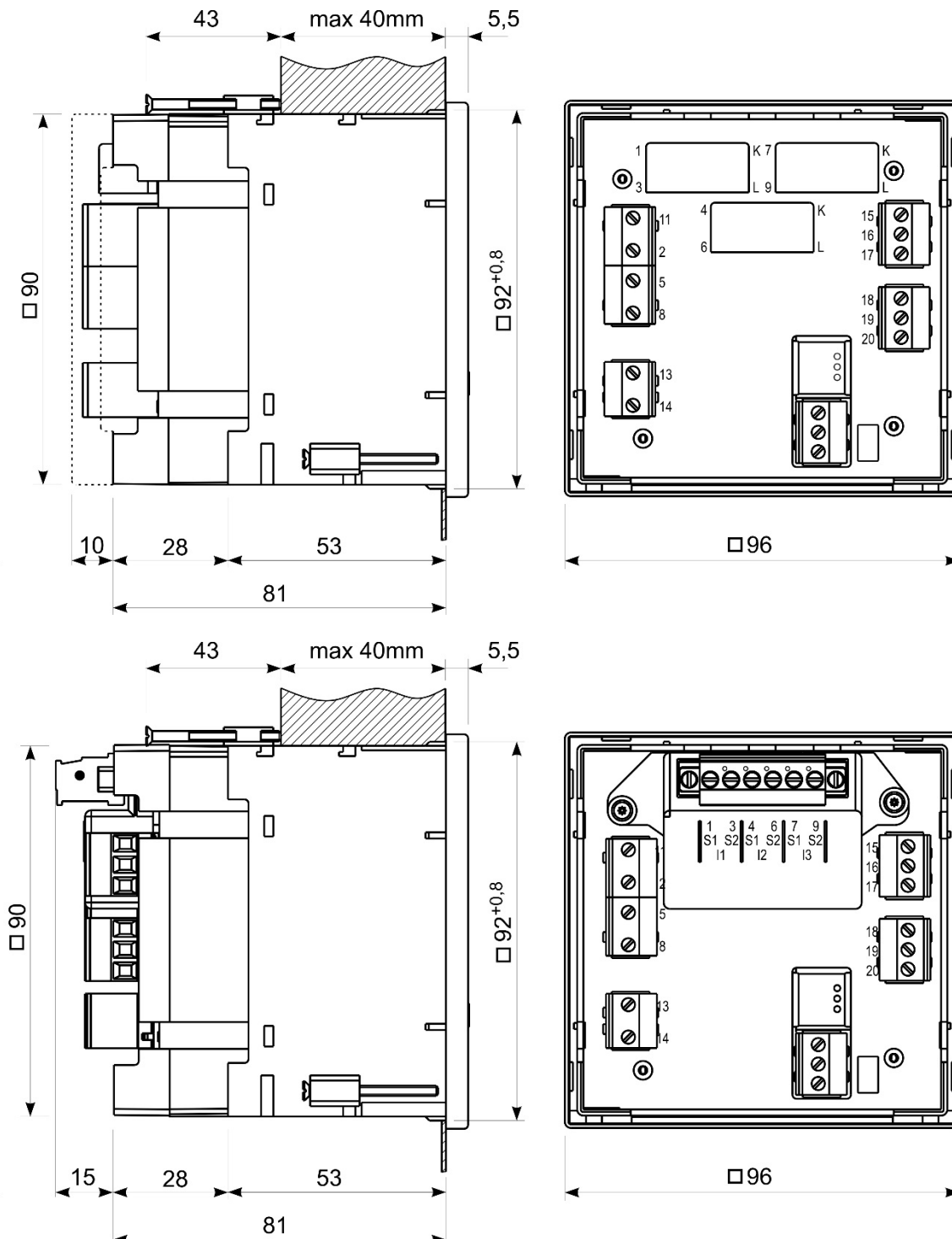

Panel cut out:
DIN 92 x 92 mm ^{+0.8}

Remove protection foil from the screen.

Electric connection

Voltage inputs of measuring centre can be connected directly to low-voltage network or via a voltage measuring transformer to high-voltage network.

There are two current connection options (defined when ordering):

- Through hole transformer
- Screw terminal connector

Depending on your current connections, refer to connection table below.

- 2 Choose corresponding connection from the figures below and connect corresponding voltages and currents. Information on electrical consumption of current and voltage inputs is given in chapter *Inputs* on page 50.

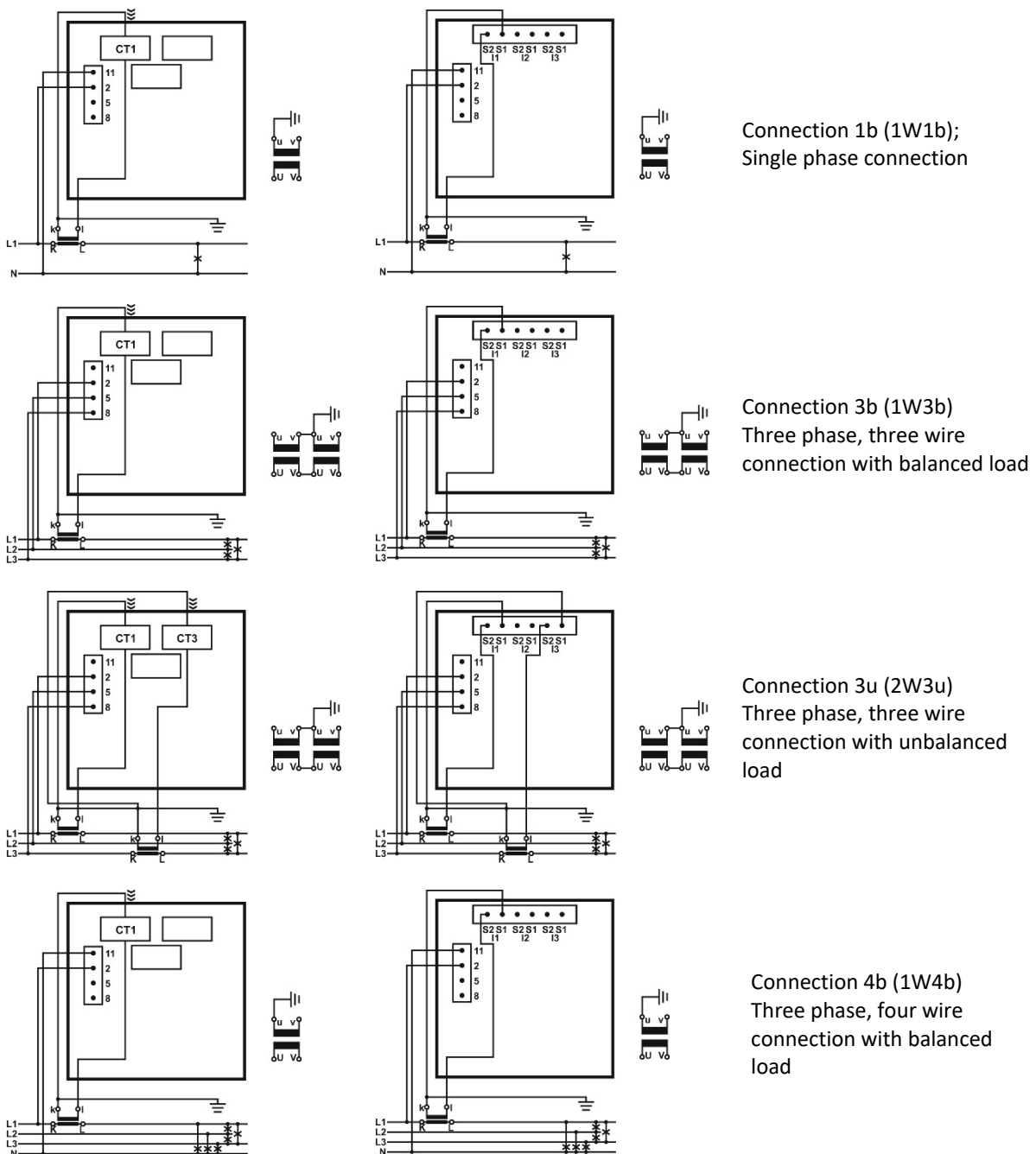

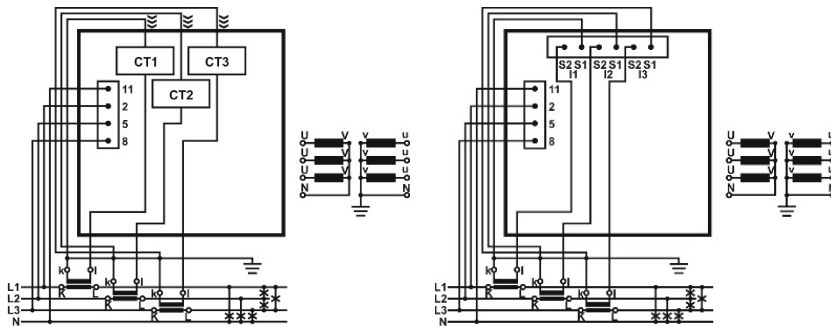

Connection 4u (3W4u)
Three phase, four wire
connection with unbalanced
load

PLEASE NOTE



Examples of connections are shown without input / output modules and communication. Connection does not depend on a number of built-in modules and communication, and is shown on the device label.

Connection of input/output modules

WARNING!

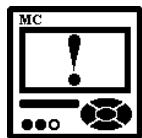

Check the module features that are specified on the label, before connecting module contacts. Wrong connection can cause damage or destruction of module and/or device.

PLEASE NOTE



Frequency of the tariff input voltage signal should not essentially deviate from the frequency of the measuring input signal. At no signal on the measuring inputs the tariff triggering is not reliable.

- 3 Connect module contacts as specified on the label. Examples of labels are given below and describe modules built in the device. Information on electrical properties of modules is given in chapter *Modules* on page 51.

<table border="1"> <thead> <tr> <th colspan="2">I/O 3/4</th> </tr> </thead> <tbody> <tr> <td>2 x Tariff input</td> <td></td> </tr> <tr> <td>230 V AC ± 20%</td> <td> <table border="1"> <tr><td>3</td><td>~</td><td>18</td></tr> <tr><td>4</td><td>~</td><td>19</td></tr> <tr><td></td><td>~</td><td>20</td></tr> </table> </td> </tr> </tbody> </table>	I/O 3/4		2 x Tariff input		230 V AC ± 20%	<table border="1"> <tr><td>3</td><td>~</td><td>18</td></tr> <tr><td>4</td><td>~</td><td>19</td></tr> <tr><td></td><td>~</td><td>20</td></tr> </table>	3	~	18	4	~	19		~	20	Tariff input module with two tariff inputs for changeover between up to four tariffs.
I/O 3/4																
2 x Tariff input																
230 V AC ± 20%	<table border="1"> <tr><td>3</td><td>~</td><td>18</td></tr> <tr><td>4</td><td>~</td><td>19</td></tr> <tr><td></td><td>~</td><td>20</td></tr> </table>	3	~	18	4	~	19		~	20						
3	~	18														
4	~	19														
	~	20														
<table border="1"> <thead> <tr> <th colspan="2">I/O 3/4</th> </tr> </thead> <tbody> <tr> <td>2 x Tariff input</td> <td></td> </tr> <tr> <td>110 V AC ± 20%</td> <td> <table border="1"> <tr><td>3</td><td>~</td><td>18</td></tr> <tr><td>4</td><td>~</td><td>19</td></tr> <tr><td></td><td>~</td><td>20</td></tr> </table> </td> </tr> </tbody> </table>	I/O 3/4		2 x Tariff input		110 V AC ± 20%	<table border="1"> <tr><td>3</td><td>~</td><td>18</td></tr> <tr><td>4</td><td>~</td><td>19</td></tr> <tr><td></td><td>~</td><td>20</td></tr> </table>	3	~	18	4	~	19		~	20	Tariff input module with two tariff inputs for changeover between up to four tariffs.
I/O 3/4																
2 x Tariff input																
110 V AC ± 20%	<table border="1"> <tr><td>3</td><td>~</td><td>18</td></tr> <tr><td>4</td><td>~</td><td>19</td></tr> <tr><td></td><td>~</td><td>20</td></tr> </table>	3	~	18	4	~	19		~	20						
3	~	18														
4	~	19														
	~	20														
<table border="1"> <thead> <tr> <th colspan="2">I/O 1/2</th> </tr> </thead> <tbody> <tr> <td>2 x S0 output</td> <td></td> </tr> <tr> <td>40 V DC 30 mA</td> <td> <table border="1"> <tr><td>1</td><td>+</td><td>15</td></tr> <tr><td></td><td>~</td><td>16</td></tr> <tr><td>2</td><td>+</td><td>17</td></tr> </table> </td> </tr> </tbody> </table>	I/O 1/2		2 x S0 output		40 V DC 30 mA	<table border="1"> <tr><td>1</td><td>+</td><td>15</td></tr> <tr><td></td><td>~</td><td>16</td></tr> <tr><td>2</td><td>+</td><td>17</td></tr> </table>	1	+	15		~	16	2	+	17	S0 (pulse) output module with two pulse outputs for energy counters.
I/O 1/2																
2 x S0 output																
40 V DC 30 mA	<table border="1"> <tr><td>1</td><td>+</td><td>15</td></tr> <tr><td></td><td>~</td><td>16</td></tr> <tr><td>2</td><td>+</td><td>17</td></tr> </table>	1	+	15		~	16	2	+	17						
1	+	15														
	~	16														
2	+	17														
<table border="1"> <thead> <tr> <th colspan="2">I/O 1/2</th> </tr> </thead> <tbody> <tr> <td>2 x Relay output</td> <td></td> </tr> <tr> <td>35 V DC 40 V AC 1000 mA</td> <td> <table border="1"> <tr><td>1</td><td>+/~</td><td>15</td></tr> <tr><td></td><td>~</td><td>16</td></tr> <tr><td>2</td><td>+/~</td><td>17</td></tr> </table> </td> </tr> </tbody> </table>	I/O 1/2		2 x Relay output		35 V DC 40 V AC 1000 mA	<table border="1"> <tr><td>1</td><td>+/~</td><td>15</td></tr> <tr><td></td><td>~</td><td>16</td></tr> <tr><td>2</td><td>+/~</td><td>17</td></tr> </table>	1	+/~	15		~	16	2	+/~	17	Relay output module with two outputs.
I/O 1/2																
2 x Relay output																
35 V DC 40 V AC 1000 mA	<table border="1"> <tr><td>1</td><td>+/~</td><td>15</td></tr> <tr><td></td><td>~</td><td>16</td></tr> <tr><td>2</td><td>+/~</td><td>17</td></tr> </table>	1	+/~	15		~	16	2	+/~	17						
1	+/~	15														
	~	16														
2	+/~	17														

<table border="1"> <thead> <tr> <th colspan="2">I/O 3/4</th> </tr> </thead> <tbody> <tr> <td colspan="2">2 x Digital input</td> </tr> <tr> <td>230 V DC/AC ± 20%</td> <td> <table border="1"> <tr> <td>3</td> <td>+/-</td> <td>18</td> </tr> <tr> <td>4</td> <td>+/-</td> <td>19</td> </tr> <tr> <td>4</td> <td>+/-</td> <td>20</td> </tr> </table> </td> </tr> </tbody> </table>	I/O 3/4		2 x Digital input		230 V DC/AC ± 20%	<table border="1"> <tr> <td>3</td> <td>+/-</td> <td>18</td> </tr> <tr> <td>4</td> <td>+/-</td> <td>19</td> </tr> <tr> <td>4</td> <td>+/-</td> <td>20</td> </tr> </table>	3	+/-	18	4	+/-	19	4	+/-	20	Digital input module with two digital inputs enables reception of impulse signals.
I/O 3/4																
2 x Digital input																
230 V DC/AC ± 20%	<table border="1"> <tr> <td>3</td> <td>+/-</td> <td>18</td> </tr> <tr> <td>4</td> <td>+/-</td> <td>19</td> </tr> <tr> <td>4</td> <td>+/-</td> <td>20</td> </tr> </table>	3	+/-	18	4	+/-	19	4	+/-	20						
3	+/-	18														
4	+/-	19														
4	+/-	20														
<table border="1"> <thead> <tr> <th colspan="2">I/O 3/4</th> </tr> </thead> <tbody> <tr> <td colspan="2">2 x Digital input</td> </tr> <tr> <td>110 V DC/AC ± 20%</td> <td> <table border="1"> <tr> <td>3</td> <td>+/-</td> <td>18</td> </tr> <tr> <td>4</td> <td>+/-</td> <td>19</td> </tr> <tr> <td>4</td> <td>+/-</td> <td>20</td> </tr> </table> </td> </tr> </tbody> </table>	I/O 3/4		2 x Digital input		110 V DC/AC ± 20%	<table border="1"> <tr> <td>3</td> <td>+/-</td> <td>18</td> </tr> <tr> <td>4</td> <td>+/-</td> <td>19</td> </tr> <tr> <td>4</td> <td>+/-</td> <td>20</td> </tr> </table>	3	+/-	18	4	+/-	19	4	+/-	20	Digital input module with two digital inputs enables reception of impulse signals.
I/O 3/4																
2 x Digital input																
110 V DC/AC ± 20%	<table border="1"> <tr> <td>3</td> <td>+/-</td> <td>18</td> </tr> <tr> <td>4</td> <td>+/-</td> <td>19</td> </tr> <tr> <td>4</td> <td>+/-</td> <td>20</td> </tr> </table>	3	+/-	18	4	+/-	19	4	+/-	20						
3	+/-	18														
4	+/-	19														
4	+/-	20														
<table border="1"> <thead> <tr> <th colspan="2">I/O 3/4</th> </tr> </thead> <tbody> <tr> <td colspan="2">2 x Digital input</td> </tr> <tr> <td>24 V DC</td> <td> <table border="1"> <tr> <td>3</td> <td>+</td> <td>18</td> </tr> <tr> <td>4</td> <td>-</td> <td>19</td> </tr> <tr> <td>4</td> <td>+</td> <td>20</td> </tr> </table> </td> </tr> </tbody> </table>	I/O 3/4		2 x Digital input		24 V DC	<table border="1"> <tr> <td>3</td> <td>+</td> <td>18</td> </tr> <tr> <td>4</td> <td>-</td> <td>19</td> </tr> <tr> <td>4</td> <td>+</td> <td>20</td> </tr> </table>	3	+	18	4	-	19	4	+	20	Digital input module with two digital inputs enables reception of impulse signals.
I/O 3/4																
2 x Digital input																
24 V DC	<table border="1"> <tr> <td>3</td> <td>+</td> <td>18</td> </tr> <tr> <td>4</td> <td>-</td> <td>19</td> </tr> <tr> <td>4</td> <td>+</td> <td>20</td> </tr> </table>	3	+	18	4	-	19	4	+	20						
3	+	18														
4	-	19														
4	+	20														
<table border="1"> <thead> <tr> <th colspan="2">I/O 3/4</th> </tr> </thead> <tbody> <tr> <td colspan="2">2 x Analogue output</td> </tr> <tr> <td>0...20 mA R_{max}=150 Ω</td> <td> <table border="1"> <tr> <td>3</td> <td>+</td> <td>18</td> </tr> <tr> <td>4</td> <td>-</td> <td>19</td> </tr> <tr> <td>4</td> <td>+</td> <td>20</td> </tr> </table> </td> </tr> </tbody> </table>	I/O 3/4		2 x Analogue output		0...20 mA R _{max} =150 Ω	<table border="1"> <tr> <td>3</td> <td>+</td> <td>18</td> </tr> <tr> <td>4</td> <td>-</td> <td>19</td> </tr> <tr> <td>4</td> <td>+</td> <td>20</td> </tr> </table>	3	+	18	4	-	19	4	+	20	Analogue output module with two analogue outputs (0...20mA), proportional to measured quantities. (MC350, MC350H with high range aux. power supply only)
I/O 3/4																
2 x Analogue output																
0...20 mA R _{max} =150 Ω	<table border="1"> <tr> <td>3</td> <td>+</td> <td>18</td> </tr> <tr> <td>4</td> <td>-</td> <td>19</td> </tr> <tr> <td>4</td> <td>+</td> <td>20</td> </tr> </table>	3	+	18	4	-	19	4	+	20						
3	+	18														
4	-	19														
4	+	20														

Communication connection

A type of connector depends on ordered communication type. RS232, RS485 and M-Bus communication are equipped with screw terminal connector, USB with USB standard B type terminal and Service USB port with mini-B type terminal.

WARNING!

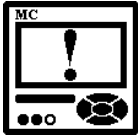

When connecting a communication connector it is necessary to assure which type RS232 or RS485 or M-Bus communication is used. Otherwise the communication module can be damaged or destroyed. See connection diagrams below.

- Corresponding data are stated on the instrument label, regarding the selected communication. Connector terminals are marked on the label on the upper side of the instrument. More detailed information on communication is given in chapter *Communication* on page 52.

RS232

RS232 communication is intended for direct connection of the Measuring centre to the personal computer. For proper operation it is necessary to assure the corresponding connection of individual terminals (see table on next page).

RS485

RS485 communication is intended for connection of devices to network where several devices with RS485 communication are connected to a common communication interface. We suggest using one of the *Iskra, d.o.o.* communication interfaces!

M-Bus (MC350 and MC350H only)

M-Bus slave interface is intended for connection to network where M-Bus master device is present. For more information regarding M-Bus please refer to Appendix D on page 65.

USB

USB communication serves as a fast peer-to-terminal data link. The device is detected by host as a USB 2.0 compatible device. The USB connection is provided through a USB standard Type B connector.



PLEASE NOTE



When MC3x0x is connected to a PC through USB communication for the first time, a user is prompted to install a driver. The driver is integrated in MiQen software or can be downloaded from the *Iskra, d.o.o.* web page www.iskra.eu. With this driver installed, USB is redirected to a serial port, which should be selected when using MiQen software.

Service USB (MC330 only)

Service USB communication serves as a fast peer-to-terminal data link. The device is detected by host as a USB 2.0 compatible device. Service USB connection is provided through a USB mini-B type connector.

Service USB is intended only for parameterisation of the meter and is not galvanic separated. Advantage is that in this case meter does not need a power supply to communicate. Communication via service port is time limited.

When using service communication, power supply and measuring voltages need to be disconnected.

WARNING!

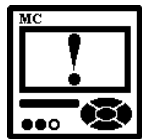

Service USB communication is not galvanic separated!

When using service USB communication, power supply and measuring voltages need to be disconnected!





PLEASE NOTE

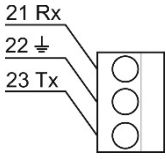
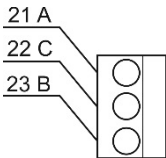
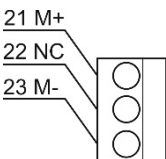

When MC3x0x is connected to a PC through USB communication for the first time, a user is prompted to install a driver. The driver is integrated in MiQen software or can be downloaded from the *Iskra, d.o.o.* web page www.iskra.eu. With this driver installed, USB is redirected to a serial port, which should be selected when using MiQen software.

Survey of communication connection

	Connector	Terminals	Position	Data direction	Description
RS232	Screw terminal		21	From	Data reception (Rx)
			22	-	Grounding (\pm)
			23	To	Data transmission (Tx)
RS485	Screw terminal		21	To/From	A
			22	-	Do not connect!
			23	To/From	B
M-Bus	Screw terminal		21	To/From	M+
			22	-	NC
			23	To/From	M-
USB	USB type B		Standard USB 2.0 compatible cable recommended (standard B type plug)		
Service USB	Mini-B type		Standard USB 2.0 compatible cable recommended (mini-B type plug)		

Connection of power supply

Measuring centre has adaptable power supply. It enables connection to certain AC power supply or universal (AC/DC) power supply. Power supply voltage depends on ordered voltage. Information on electric consumption is given in chapter *Technical data* on page 49.

- 5 Regarding power supply voltage specification on the label choose and connect the power supply voltage:

INPUTS	
Current: 5 A	
Voltage: 240 V	
Frequency: 50, 60 Hz	
Connect.: 4u	
Class: 0.5	
SUPPLY	
20...300 V DC	13
48...276 V AC	
40...65 Hz	
< 5 VA	14

Connection of universal power supply to terminals 13 and 14.

Example for MC350!

INPUTS	
Current: 5 A	
Voltage: 500 V	
Frequency: 50, 60 Hz	
Connect.: 4u	
Class: 0.5	
SUPPLY	
230, 240 V AC	13
40...65 Hz	
< 5 VA	
	14

Connection of AC power supply to terminals 13 and 14.

Example for MC350!

FIRST STEPS

INTRODUCTION.....	20
DISPLAY OF DEVICE INFO.....	22

Introduction

Instruction for work with measuring centre is given in the following chapters. Procedure can differ regarding the types and their configuration (functions support). More than one procedure can be used for some types.



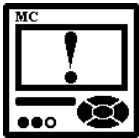

WARNING!



Measuring centre start-up begins after electrical connection. After proper connection it is assured that the user security is not threatened. After correct switch-on and respected safety measures the work with device does not represent any danger for a user.

Basic concepts

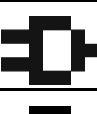
Navigation keys and LCD enable application and basic device settings. During the operation some icons can be displayed in upper part of LCD. The significance of icons (from right to left) is explained in the table below.

Icon	Meaning
	Device is locked with a password of the second level (L2). The first level (L1) can be unlocked.
	Device can be wrongly connected at 4u connection. Energy flow direction is different by phases.
	The device supply is too low.
	Clock not set (MC350, MC350H only)

Example (MC330):

 Main menu ⇒ Info OK ↑

Info
🔒 Locked
⚡ Wrong connection
⚡ Low supply
⬅ Main menu



Meaning of icons is displayed on LCD in the Information menu.

Installation wizard

After installation and electrical connection, basic parameters have to be set in order to assure correct operation. The easiest way to achieve that is use the Installation wizard. When entering the Installation menu, settings follow one another when the previous one is confirmed. All required parameters shall be entered and confirmed. Exit from the menu is possible when all required settings are confirmed or with interruption (key ← several times) without changes.



PLEASE NOTE



All settings that are performed through the Installation wizard can be subsequently changed by means of the Settings menu or via MiQen by means of communication.



Main menu ⇒ Installation ⇒

The menus follow one after another:

START MENU

Start screen is displayed on LCD.

LANGUAGE

Set device language.

DATE (MC350, MC350H ONLY)

Set device date.

TIME (MC350, MC350H ONLY)

Set device time.

CONNECTION MODE

Choose connection and define load connection.

PRIMARY VOLTAGE

Set primary voltage if a voltage transformer is used.

SECONDARY VOLTAGE

Set secondary voltage if a voltage transformer is used; set voltage of low voltage network if connection is direct.

PRIMARY CURRENT

Set primary current if a current transformer is used.

SECONDARY CURRENT

Set secondary current.

COMMON ENERGY EXPONENT (MC350, MC350H ONLY)

Define common energy exponent as recommended in table below, where counter divider is at default value 10. Values of primary voltage and current determine proper Common energy exponent. For detailed information see chapter *Energy* on page 32.

Current \ Voltage	1 A	5 A	50 A	100 A	1000 A
110 V	-1 (100 mWh)	0 (1 Wh)	1 (10 Wh)	1 (10 Wh)	2 (100 Wh)
230 V	0 (1 Wh)	0 (1 Wh)	1 (10 Wh)	2 (100 Wh)	3 (1 kWh)
1000 V	0 (1 Wh)	1 (10 Wh)	2 (100 Wh)	3 (1 kWh)	4 (10 kWh)
30 kV	2 (100 Wh)	2 (100 Wh)	3 (1 kWh)	4 (10 kWh)	4* (10 kWh)

* - Counter divider (MiQen 2.x and above - Individual Counter Resolution) should be at least 100

DEVICE ADDRESS

Set MODBUS address for the device. Default address is 33.

BITS PER SECOND

Set communication rate. Default rate is 115200 b/s.

PARITY

Set communication parity. Default value is None.

STOP BIT

Set communication stop bits. Default value is 2.

Display of device info

A menu is divided into several submenus with data and information about device:

- Welcome screen
- Information
- Meaning of icons

Welcome screen

When entering the information menu, a welcome screen is displayed on LCD showing type designation and name of measuring centre.



Main menu ⇒ Info OK

Information

Data on a device are collected in the Information menu. They include a serial number, a software version, a hardware version, date of manufacture and a number of operational hours in days, hours and minutes.



Main menu ⇒ Info OK ↓



Main menu ⇒ Info OK ↓ ↓

Meaning of icons

All possible icons with their meaning are displayed.



Main menu ⇒ Info OK ↓ ↓ ↓ ↓



Example of display of icons with their meaning without active icons and at locked MC:

Info
🔒 Locked
⚡ Wrong connection
🔋 Low supply
🏠 Main menu

⇒

After automatic
password activation

⇒

Info
🔒 Locked
⚡ Wrong connection
🔋 Low supply
🏠 Main menu

SETTINGS

INTRODUCTION.....	23
MIQEN SOFTWARE	23
SETTING PROCEDURE	25
GENERAL SETTINGS	26
CONNECTION	28
COMMUNICATION.....	29
DISPLAY	30
SECURITY	31
ENERGY - COUNTERS	32
INPUTS AND OUTPUTS.....	34
ALARMS.....	37
MEMORY (MC350 AND MC350H ONLY)	38
RESET OPERATIONS	39

Introduction

Settings of measuring centre can be done via the front keyboard or with a PC and MiQen software. Setting is easier using MiQen. Basic and simpler settings are accessible via navigation keyboard. For new setting to be activated settings file should be transferred to the device via communication (MiQen) or memory card. Setting done via navigation keyboard comes in to function after confirmation (OK).

MiQen software

MiQen software is a tool for complete monitoring of the measuring instruments. RS485 or RS232 or USB is used for connection with a PC. A user-friendly interface consists of five segments: devices management, instrument settings, real-time measurements, data analysis and software upgrading.



PLEASE NOTE



You can download freeware MiQen from www.iskra.eu.

Devices management

In MiQen it is very easy to manage devices. If dealing with the same device, it can be easily selected from a favourite's line. Use the network explorer to set and explore the devices in serial network or browser for Ethernet devices connected in local Ethernet network. Also setting of communication parameters to establish communication with a single device can easily be done.

Device settings

Multi Register Edit technology assures a simple modification of settings that are organized in a tree structure. Besides transferring settings into the device, storing and reading from the setting files and memory cards are also available.

Real-time measurements

All supported measurements can be seen in real time in a table or graphical form. For further processing of the results of measurements, it is possible to set a recorder on active device that will record and save selected measurements to MS Excel .csv file format.

Data analysis

Analysis can be performed for the devices with a built-in memory. Recorded quantities can be monitored in a tabular or a graphical form. The events that triggered alarms can be analysed or a report on supply voltage quality can be made. All data can be exported to MS Excel worksheets.

Software upgrading

Always use the latest version of software, both MiQen and software in the device. The program automatically informs you about available upgrades that can be transferred and used for upgrading.



PLEASE NOTE



More information about MiQen software can be found in MiQen Help system!

PC MiQen 2.x user interface

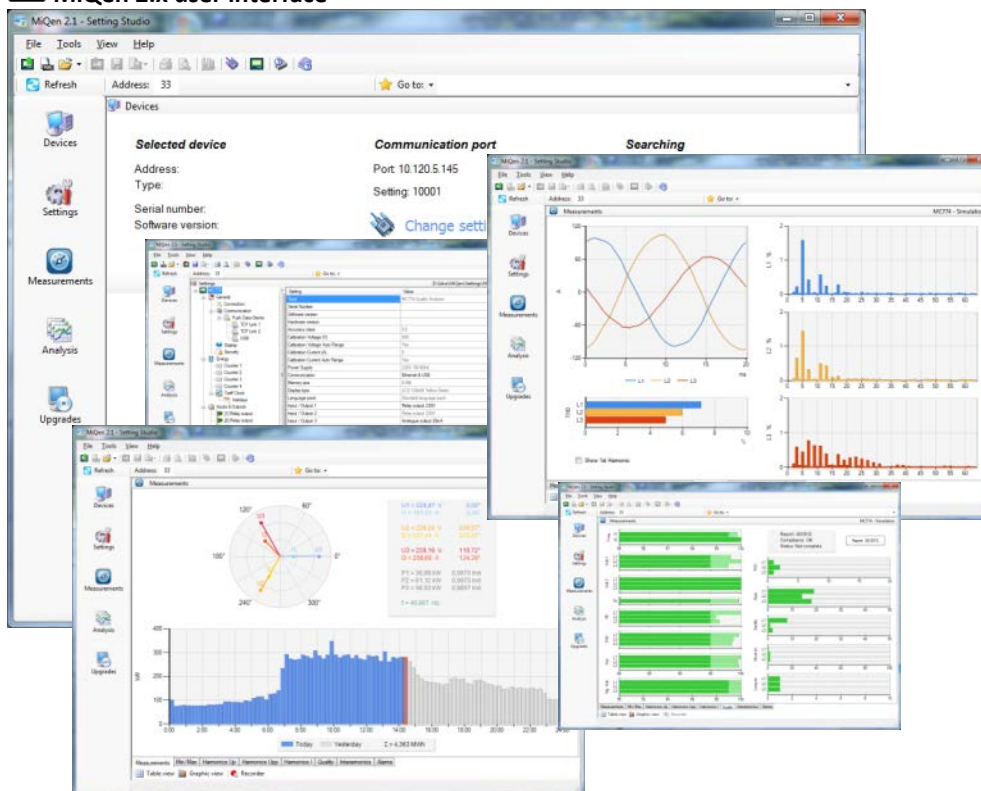

Setting procedure

Before setting the instrument by means of MiQen, the current settings should be read first. Reading is available either via communication or from a file (stored on a PC local disk). A setting structure that is similar to a file structure in an explorer is displayed in the left part of the MiQen setting window. Available settings of that segment are displayed in the right part by clicking any of the stated parameters.



PLEASE NOTE



Some settings are probably not available due to unsupported measurements and/or functions that depend on the device type. For a survey of supported measurements and functions see chapter *Type differences*, pages 11.

General settings

General settings are essential for measuring centre. They are divided into four additional sublevels (Connection, Communication, Display and Security).

Description and Location

These two parameters are intended for easier recognition of a certain unit. They are especially used for identification of the device or location on which measurements are performed.

Average interval

The averaging interval defines a refresh rate of measurements on LCD and communication.

It is used also as averaging interval for minimum and maximum values stored in recorder (MC350) and actual alarm value calculation for alarm triggering (MC330, MC350 and MC350H).

- Shorter average interval means better resolution in minimum and maximum value in to recorded period detection and faster alarm response. Also data presented in display will refresh faster.
- Longer average interval means lower minimum and maximum value in recorded period detection and slower alarm response (alarm response can be delayed also with Compare time delay setting – See chapter *Alarms* on page 37). Also data on display will refresh slower.

Language

Set language on LCD. When language is changed from or to Russian, characters of the password are changed too. For overview of character translation see chapter *Password and language* on page 32.

 Main menu ⇒ Settings ⇒ General ⇒ Language



PLEASE NOTE



 If a wrong language is set, a menu of languages can be displayed by simultaneous pressing up and down keys.

Temperature unit

Choose a unit for temperature display.

 Main menu ⇒ Settings ⇒ General ⇒ Temperature unit

Date format (MC350 and MC350H only)

Set a date format.

 Main menu ⇒ Settings ⇒ Date & Time ⇒ Date format

Date and time (MC350 and MC350H only)

Set date and time of the device. Setting is important for correct memory operation, maximal values (MD), etc.

 Main menu ⇒ Settings ⇒ Date & Time ⇒ Date / Time

Auto Summer/Winter time (MC350 and MC350H only)

If Yes is chosen, time will be automatically shifted to a winter or a summer time, regarding the time that is momentarily set.

 Main menu ⇒ Settings ⇒ Date & Time ⇒ Automatic S/W time

Maximum demand (MD) time constant PC

The instrument provides maximum demand values based on a thermal function. Thermal function time constant can be selected via keyboard or via communication.

 Main menu ⇒ Settings ⇒ General ⇒ MD mode / MD time constant

THERMAL FUNCTION

A thermal function assures exponent thermal characteristic based on simulation of bimetal meters. Maximal values and time of their occurrence are stored in device. A time constant (t. c.) can be set from 1 to 255 minutes and is 6 – time thermal time constant (t. c. = 6 * thermal time constant).

Example:

Mode: Thermal function

Time constant: 8 min.

Current MD and maximal MD: Reset at 0 min.

Thermal function

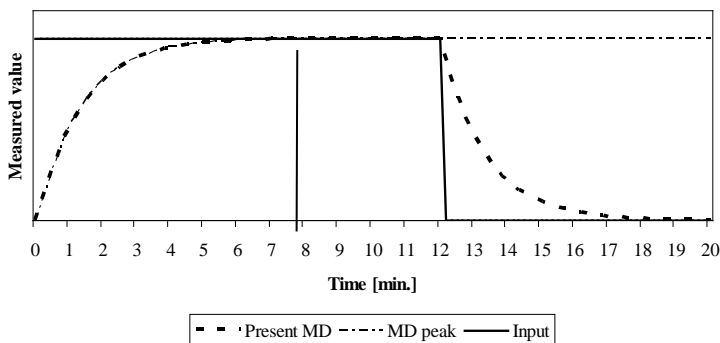

Starting current for PF and PA (mA) PC

At all measuring inputs noise is usually present. It is constant and its influence on the accuracy is increased by decreasing measuring signals. It is present also when measuring signals are not connected and it occurs at all further calculations as very sporadic measurements. By setting a common starting current, a limit of input signal is defined where measurements and all other calculations are still performed.

Starting current for all powers (mA) PC

Noise is limited with a starting current also at measurements and calculations of powers.

Starting voltage for all powers PC

Noise is limited with a starting voltage also at measurements and calculations of powers. Until voltage reaches user defined starting voltage limit, all powers are set to 0. Using three wire electrical connections, virtual phase voltage is used in calculations.

Starting voltage for SYNC PC

If all voltages are less than Starting voltage for SYNC, than the current inputs are used for synchronisation. If all currents are less than Starting current for PF and PA, than the synchronisation is stopped and the frequency result is 0 Hz

Reactive power and energy calculation

User can select between two different principles of reactive power and energy calculation:

Standard method:

With this method a reactive power and energy are calculated based on assumption that all power (energy) that is not active is reactive.

$$Q^2 = S^2 - P^2$$

This means also that all higher harmonics (out of phase with base harmonic) will be measured as reactive power (energy).

Delayed current method:

With this method, reactive power (energy) is calculated by multiplication of voltage samples and delayed current samples (see chapter *Equations* on page 69):

$$Q = U \times I |_{+90^\circ}$$

With this method, reactive power (energy) represents only true reactive component of apparent power (energy).

Connection



PLEASE NOTE



Settings of connections shall reflect actual state otherwise measurements are not valid.

Connection

When connection is selected, load connection and the supported measurements are defined (see chapter *Survey of supported measurements regarding Connection mode* on page 21).

 Main menu ⇒ Settings ⇒ Connection ⇒ Connection mode

Setting of current and voltage ratios

Before setting current and voltage ratios it is necessary to be familiar with the conditions in which device will be used. All other measurements and calculations depend on these settings. Up to five decimal places can be set (up / down). To set decimal point and prefix (up / down) position the cursor (left / right) to last (empty) place or the decimal point.

Settings range	VT primary	VT secondary	CT primary	CT secondary
Maximal value	1638.3 kV	13383 V	1638.3 kA	13383 A
Minimal value	0.1 V	1 mV	0.1 A	1 mA

 Main menu ⇒ Settings ⇒ Connection ⇒ VT primary / VT secondary / CT primary / CT secondary

Used voltage and current range

Setting of the range is connected with all settings of alarms, where 100% represents 500 V and 5A. In case of subsequent change of the range, alarms settings shall be correspondingly changed, as well.

Nominal frequency

A valid frequency measurement is within the range of nominal frequency ± 32 Hz. This setting is used for alarms only.

Wrong connection warning

If all phase currents (active powers) do not have same sign (some are positive and some negative) and/or if phase voltages and phase currents are mixed, the warning will be activated if this setting is set to YES. This warning is seen only on remote display.

Energy flow direction

This setting allows manual change of energy flow direction (IMPORT to EXPORT or vice versa) in readings tab. It has no influence on readings sent to communication or to memory.

CT connection

If this setting is set to REVERSED it has the same influence as if CT's would be reversely connected. All power readings will also change its sign.

Communication

Serial Communication

They define parameters that are important for the operation in RS485 network or connections with PC via RS232 communication. Factory settings of communication are #33\115200,n,8,2 (address 1 to 247\rate 2400 to 115200 b/s, parity, data bits, stop bit).



Main menu ⇒ Settings ⇒ Communication ⇒

USB Communication

Has no setting. Device is automatically recognized in Windows environment if device driver has been correctly installed. For more detailed information how to handle device with USB communication use Help section in MiQen software.

Service USB Communication (MC330 only)

Has no setting. Device is automatically recognized in Windows environment if device driver has been correctly installed. For more detailed information how to handle device with USB communication use Help section in MiQen software



PLEASE NOTE



Service USB is intended only for parameterisation of the meter and is not galvanic separated. Advantage is that in this case meter does not need a power supply to communicate. Communication via service port is time limited.



WARNING!

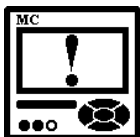

Service USB communication is not galvanic separated!

When using service USB communication, power supply and measuring voltages need to be disconnected!

M-Bus Communication

To set M-Bus communication please see Appendix D.

Display

Display settings

A combination of setting of the contrast and back light defines visibility and legibility of a display. Display settings shall be defined in compliance with the conditions in which it will be monitored. Economizing mode switches off back light according to the set time of inactivity.

 Main menu \Rightarrow Settings \Rightarrow LCD \Rightarrow Contrast / Back light / Back light time off

Demo cycling period

It defines time in seconds for each displayed screen of measurements on LCD.

 Main menu \Rightarrow Settings \Rightarrow LCD \Rightarrow Demo cycling period

Settings of customized screens

For easier and faster survey of measurements that are important for the user, three settings of customized screens are available. Each customized screen displays three measurements. When setting customized screens the designations are displayed in shorter form, with up to 4 characters. For survey of all designations see chapter *Survey of supported measurements regarding Connection* on page 13.

Example:

Desired result:

Customized screen 1	Customized screen 2	Customized screen 3
Phase voltage 1	Total current	Power angle (U_1-I_1)
Phase current 1	Neutral current	Frequency
Phase power 1	Average current	THD of current I_1

Setting:

 Main menu \Rightarrow Settings \Rightarrow LCD \Rightarrow Custom screen 1 / 2 / 3

Customized screen 1

Custom screen 1
U1 I1 P1
OK Select

Customized screen 2

Custom screen 2
I Inc Iavg
OK Select

Customized screen 3

Custom screen 3
ϕ1 f 11%
OK Select

 Main menu \Rightarrow Measurements \Rightarrow Present values \Rightarrow Custom OK

<table border="1"> <tbody> <tr> <td>225.2₆ V U1</td> </tr> <tr> <td>55.3₁ mA I1</td> </tr> <tr> <td>10.3₉ W P1</td> </tr> </tbody> </table>	225.2₆ V U1	55.3₁ mA I1	10.3₉ W P1	\Leftrightarrow	<table border="1"> <tbody> <tr> <td>0.396₁ A I</td> </tr> <tr> <td>0.38₆ A Inc</td> </tr> <tr> <td>0.132₀ A Iavg</td> </tr> </tbody> </table>	0.396₁ A I	0.38₆ A Inc	0.132₀ A Iavg	\Leftrightarrow	<table border="1"> <tbody> <tr> <td>+4.3₆ ° ϕ1</td> </tr> <tr> <td>49.996₄ Hz f</td> </tr> <tr> <td>87.5₆ % THD</td> </tr> </tbody> </table>	+4.3₆ ° ϕ1	49.996₄ Hz f	87.5₆ % THD
225.2₆ V U1													
55.3₁ mA I1													
10.3₉ W P1													
0.396₁ A I													
0.38₆ A Inc													
0.132₀ A Iavg													
+4.3₆ ° ϕ1													
49.996₄ Hz f													
87.5₆ % THD													

Security

Settings parameters are divided into four groups regarding security level:

- 1 At the lowest level (PL0), where a password is not required, parameters of LCD can be set: language, contrast and LCD back light.
- 2 At the first level (PL1), settings of a real time clock (MC350 and MC350H) can be changed and energy meters and MD can be reset.
- 3 At the second level (PL2), the access to all data that are protected with the first level (PL1) and setting of all other parameters in the »SETTINGS« menu are available.
- 4 A backup password (BP) is used if passwords at levels 1 (PL1) and 2 (PL2) have been forgotten, and it is different for each device (depending on a serial number of the meter). The BP password is available in the user support department in *Iskra, d.o.o.*, and is entered instead of the password PL1 or/and PL2. Do not forget to state the meter serial meter when contacting the personnel in *Iskra, d.o.o.*.



PLEASE NOTE



A serial number of device is stated on the label, LCD (see example below) and is also accessible with MiQen software.

The access to the device serial number via a keyboard

Example:

 Main menu ⇒ Info OK ↓

Main menu
Measurements
Settings
Resets
Info
Installation
Temperature 41.4°C

OK

ISKRA
MC350
Recorder
ISKRA

↓

Info
Ser. #: MC300005
S.ver: 0,28
H.ver: A
Date : 21.05.2009
Run : 15d 13h 51'
⌂ Main menu

Password setting

A password consists of four letters taken from the British alphabet from A to Z. When setting a password, only the letter being set is visible while the others are covered with *.

A password of the first (L1) and the second (L2) level is entered, and time of automatic activation is set.

 Main menu ⇒ Settings ⇒ Security ⇒ Password level 1 / Password level 2 / Password lock time

Password modification

A password is optionally modified; however, only that password can be modified to which the access is unlocked at the moment.

 Main menu ⇒ Settings ⇒ Security ⇒ Password level 1 / Password level 2

Password disabling

A password is disabled by setting the "AAAA" password.

 Main menu ⇒ Settings ⇒ Security ⇒ Password level 1 / Password level 2 ⇒ "AAAA" OK



PLEASE NOTE



A factory set password is "AAAA" at both access levels (L1 and L2). This password does not limit access.

Password and language

Language change is possible without password input. When language is changed from or to Russian or Hebrew, character transformation has to be taken in to account. Character transformation table (English or Russian alphabet) is stated below.

English	A	B	C	D	E	F	G	H	I	J	K	L	M	N	O	P	Q	R	S	T	U	V	W	X	Y	Z
Russian	А	Б	В	Г	Д	Е	Ж	З	И	Й	К	Л	М	Н	О	П	Р	С	Т	У	Ф	Х	Ц	Ч	Ш	Щ

Energy - counters

WARNING!

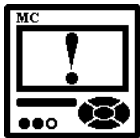

Before modification, all energy counters should be read or if energy values are stored in recorders, recorder should be read with MiQen software or stored on Memory card to assure data consistency for the past.

After modification of energy parameters, the energy meters (counters) should be reset. All recorded measurements from this point back might have wrong values so they should not be transferred to any system for data acquisition and analysis. Data stored before modification should be used for this purpose.

Active tariff

When active tariff is set, one of the tariffs is defined as active; switching between tariffs is done either with a tariff clock or a tariff input. For the operation of the tariff clock other parameters of the tariff clock that are accessible only via communication or Memory card must be set correctly.

Common Energy Exponent (Common Energy Counter Resolution – MiQen 2.x and above)

Common energy exponent defines minimal energy that can be displayed on the energy counter. On the basis of this and a counter divider, a basic calculation prefix for energy is defined (-3 is $10^{-3}\text{Wh} = \text{mWh}$, 4 is $10^4\text{Wh} = 10 \text{ kWh}$). A common energy exponent also influences in setting a number of impulses for energy of pulse output or alarm output functioning as an energy meter.

Define common energy exponent as recommended in table below, where counter divider is at default value 10. Values of primary voltage and current determine proper Common energy exponent.

In MiQen setting software version 2.x and above, this setting parameter is renamed in Common Energy Counter Resolution. Also setting values are changed to give user better perspective of represented value.

In table below, new setting values are quoted in parenthesis.

Current Voltage	1 A	5 A	50 A	100 A	1000 A
110 V	-1 (100 mWh)	0 (1 Wh)	1 (10 Wh)	1 (10 Wh)	2 (100 Wh)
230 V	0 (1 Wh)	0 (1 Wh)	1 (10 Wh)	2 (100 Wh)	3 (1 kWh)
1000 V	0 (1 Wh)	1 (10 Wh)	2 (100 Wh)	3 (1 kWh)	4 (10 kWh)
30 kV	2 (100 Wh)	2 (100 Wh)	3 (1 kWh)	4 (10 kWh)	4* (10 kWh)

* - Counter divider (MiQen 2.x and above - Individual Counter Resolution) should be at least 100

Counter divider (Individual counter Resolution – MiQen 2.x and above)

The counter divider additionally defines precision of a certain counter, according to settings of common energy exponent.

An example for 1kW of consumed active energy in the first tariff:

Common energy exponent	0	2	2
Counter divider	1	1	100
Example of result, displayed	2.577 kWh	0.2577 MWh	25.77 MWh

Tariff clock

Basic characteristics of a program tariff clock:

- 4 tariffs (T1 to T4)
- Up to 4 time spots in each Day program for tariff switching
- Whichever combination of valid days in a week or holidays for each program
- Combining of day groups (use of over 4 time spots for certain days in a week)
- Separate settings for 4 seasons a year
- Up to 20 settable dates for holidays

OPERATION OF INTERNAL TARIFF CLOCK

Tariff status is displayed in the Info menu.

Example of display for selected Active tariff:

 Main menu ⇒ Info OK ↓ ↓ ↓ ⇒

Tariff status
Season: 1
Day programs
P1 -- -- --
Tariff: T3
← Info

or

Tariff status
Selected: T2
← Info

or

Tariff status
Tariff input
Selected: T1
← Info

Day program sets up to 4 time spots (rules) for each day group in a season for tariff switching.

A date of real time clock defines an active period. An individual period is active from the period starting date to the first next date of the beginning of other periods.

The order of seasons and starting dates is not important, except when two dates are equal. In that case the season with a higher successive number has priority, while the season with a lower number will never be active.

If no starting date of a season is active, the active period is 1.

If the present date is before the first starting date of any period, the period is active with the last starting date.

Example of settings:

Season	Season start day
Season 1:	15.02
Season 2:	30.10
Season 3:	-
Season 4:	01.06
Date	Active season
01.01. - 14.02.	2 (last in the year)
15.02. - 31.05.	1
01.06. - 29.10.	4
30.10. - 31.12.	2

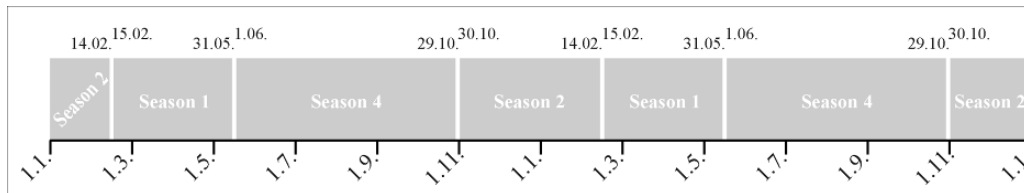

Days in a week and selected dates for holidays define time spots for each daily group in a period for tariff switching. Dates for holidays have priority over days in a week.

When the real time clock date is equal to one of a date of holidays, tariff is switched to holiday, within a period of active daily group with a selected holiday.

If there is no date of holidays that is equal to the real time clock date, all daily groups with the selected current day in a week are active.

Several daily groups can be active simultaneously, which enables more than 4 time spots in one day (combine of day programs). **If the time spot is not set for a certain day, tariff T1 is chosen.**

Time of a real time clock defines an active tariff regarding currently active day program. A selected tariff T1 to T4 of individual time spot is active from the time of the time spot to the first next time of the remaining time spots.

The order of time spots is not important, except when two times are equal. In that case the time with a higher successive number has priority (if several time spots are active, times of higher time spots have higher successive numbers), while the time spot with a lower number will never be active.

If current time is before the first time of any time spot of active spots, the time spot with the last time is chosen.

If no time spot of active programs is valid, tariff T1 is chosen.

Time selected tariff T1 to T4 or fixed selected tariff (via communication) defines activity of an energy counter.

Counter measured quantity PC

For each of four (4) counters different measured quantity can be selected. User can select from a range of predefined options referring to measured total energy or energy on single phase. Or can even select its own option by selecting appropriate quantity, quadrant, absolute or inverse function.

To energy counter also pulse / digital input can be attached. In this case Energy counter counts pulses from an outside source (water, gas, energy... meter).

Inputs and outputs

MC3x0x can be equipped with different I/O. For its technical specifications see chapter *Technical data* on page 49.

For I/O 1 and 2 following options are available.

Module 1 - Outputs: There are two different output modules.

- Pulse output (solid state)
- Relay output (relay)

Module 2 - Inputs: There are two different input modules.

- Digital input
- Tariff input

Tariff and digital input can be ordered as a different hardware types with different voltage levels.

All modules have double input or output and are in MiQen software presented as two separate modules.

Relay output and a pulse output can also be selected via a keyboard. When selecting settings of energy and quadrants for a certain counter, only present selection is possible, while more demanding settings are accessible via communication.

Pulse (S0) module

It is a solid state, optocoupler open collector switch. Its main intention is to be used as a pulse output for selected energy counter, but can also be used as an alarm or general purpose digital output.

For description of output functionality see chapter Functions of Digital output (Pulse and Relay) modules below.

Relay (alarm) module

It is a relay switch. Its main intention is to be used as an alarm output, but can also be used as a pulse or general purpose digital output.

A parallel RC filter with time constant of at least 250 μ s ($R \cdot C \geq 250 \mu$ s) should be used in case of a sensitive pulse counter. RC filter attenuates relay transient signals.

For description of output functionality see chapter Functions of Digital output (Pulse and Relay) modules below.

Functions of output modules (Pulse and Relay)

To Digital outputs, Pulse and Relay, different functions can be attached. All can be set with MiQen software.

PULSE OUTPUT OF ENERGY COUNTER

A corresponding energy counter is defined to a pulse output. A number of pulses per energy unit, pulse length, and a tariffs in which output is active are set.

WARNING!

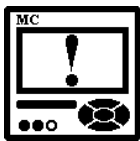

Pulse parameters are defined by EN 62053–31 standard. In chapter Calculation of recommended pulse parameters, below a simplified rule is described to assist you in setting the pulse output parameters.

 Main menu \Rightarrow Settings \Rightarrow Inputs/Outputs \Rightarrow I/O 1 / 2 / 3 / 4 \Rightarrow Setting of pulse output OK

The pulse module can also function as an alarm output with maximum current load 30 mA.

CALCULATION OF RECOMMENDED PULSE PARAMETERS

Number of pulses per energy unit should be in certain limits according to expected power. If not so the measurement from pulse output can be incorrect. Settings of current and voltage transformers can help in estimation of expected power.

Principle described below for pulse setting, where e is prefix, satisfies EN 62053-31: 2001 standards pulse specifications:

1,5...15 eW \rightarrow 100 p/1 eWh

Examples:

Expected power	\rightarrow	Pulse output settings
150 - 1500 kW	\rightarrow	1 p/1kWh
1.5 - 15 MW	\rightarrow	100 p/1MWh
15 - 150 MW	\rightarrow	10 p/1MWh
150 - 1500 MW	\rightarrow	1 p/1MWh

CALCULATION OF RECOMMENDED PULSE PARAMETERS

If Digital output is defined as an Alarm output, its activity (trigger) is connected to Alarm groups. Multiple alarm groups can be attached to it and different signal shapes defined. For more information on how to define alarm groups, see chapter *Alarms* on page 37.

Alarm groups connected to a specific output module can also be defined via keyboard.

 Main menu \Rightarrow Settings \Rightarrow Inputs/Outputs \Rightarrow V/I 1 / 2 / 3 / 4 \Rightarrow Setting of alarm output OK

SIGNAL SHAPE:

- Normal – a relay is closed until condition for the alarm is fulfilled.
- Normal inverse – a relay is open until condition for the alarm is fulfilled.
- Latched – a relay is closed when condition for the alarm is fulfilled, and remains closed until it is reset via communication.
- Latched inverse – a relay is opened when condition for the alarm is fulfilled, and remains closed until it is reset via communication.
- Pulsed – an impulse of the set length is sent always when condition for the alarm is fulfilled.
- Pulsed inverse – a pause of the set length is sent always when condition for the alarm is fulfilled. Otherwise relay is closed.
- Always switched on / off (permanent) – A relay is permanently switched on or switched off irrespective of the condition for the alarm.



This possibility of permanent alarm setting enables remote control via communication.

Digital input module PC

Module has no settings. General purpose is to collect digital signals from various devices, such as (intrusion detection relay, different digital signals in transformer station, industry ...). It is available in three different hardware versions.

When used in DC mode it can also be used as a pulse counter from external meters (water, gas, heat ...). Its value can be assigned to any of four energy counters (see chapter *Energy* on page 32).

Tariff input module PC
TARIFF INPUT

Has no setting. It operates by setting active tariff at a tariff input (see chapter *Tariff clock* on page 33). The instrument can have maximal one module with 2 tariff inputs only. With the combination of 2 tariff inputs maximal 4 tariffs can be selected.

ACTIVE TARIFF SELECTION TABLE:

Active tariff	Signal presence on tariff input	
	Input T1/T2	Input T3/T4
Tariff 1	0	0
Tariff 2	1	0
Tariff 3	0	1
Tariff 4	1	1

Alarms

Alarms are used for alarming exceeded set values of the measured quantities.

Alarms setting PC

Measuring centre supports alarm functionality. 16 alarms divided in 2 groups (2 x 8 alarms) can be set. For each group of alarms a time constant of maximal values in thermal mode, a delay time and alarm deactivation hysteresis can be defined.

Quantity, value (a current value or a MD – thermal function) and a condition for alarm switch-on are defined for every individual alarm.

MC350 supports also storing of alarms in internal memory.

WARNING!

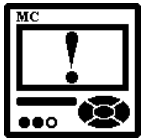

New values of alarms are calculated in percentage at modification of connection settings.

Alarms setting PC

Device evident all triggered alarms and stores it in internal RAM. Statistic is valid since last power supply On and could be reset with MiQen software (See chapter *Reset operations* on page 39)

Types of alarms

VISUAL ALARM

When alarm is switched on, a red LED on the meter front side is blinking (see figure shown on next page).

ALARM OUTPUT (PULSE)

According to the alarm signal shape the output relay will behave as shown on next page.

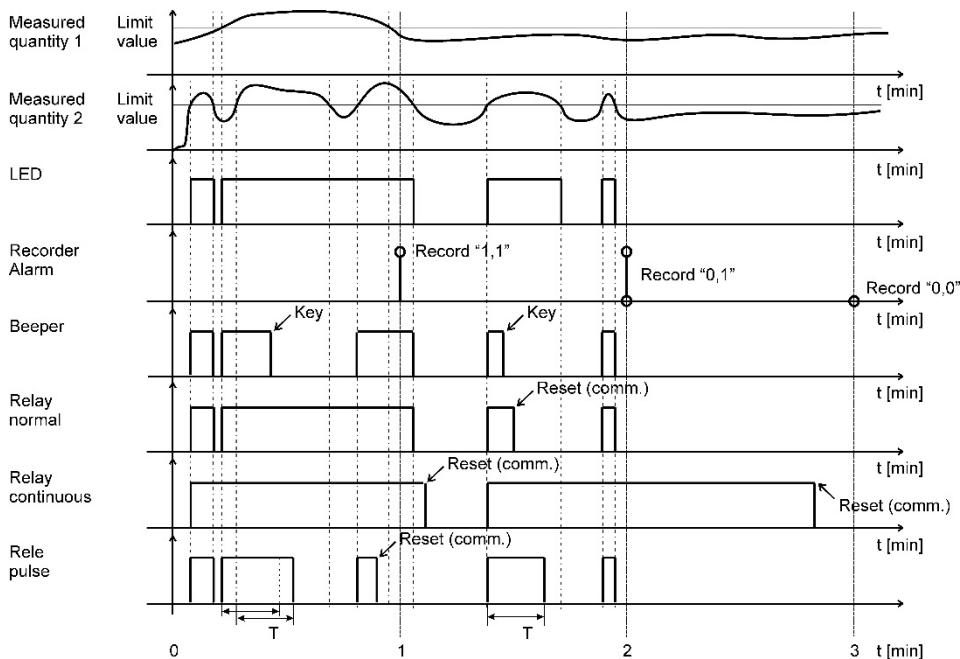

Memory (MC350 and MC350H only)

Measurements and alarms can be stored in a built in 8MB flash memory. All records stored in memory are accessible via communication with MiQen software.

Memory division

MC memory is divided into 3 partitions which size is defined by the user. Measurements are stored in A and B partitions, while all alarms that occurred are recorded in an alarm partition.

Memory operation

Memory functions in a cyclic mode in compliance with the FIFO method. This means that only the latest records are stored in the memory that will replace the oldest ones. A number of stored data or a storing period depends on selected partition size, a number of recorded quantities and time of division sampling. Occupancy of partitions is shown in the Information menu (see chapter *Display* of device info on page 29).

Memory clearing

There is usually no need to clear the memory, because it works in cyclic mode. If you want to clear memory data anyway, the data storing must be stopped first. Read the device settings with MiQen and set "Recorder state" in Memory setting group to stopped. Download changes to the device and open Memory info form and then click on Clear memory button. Select memory partitions to be cleared on Memory clearing form and click on OK button. Set "Recorder state" setting back to active.

WARNING!

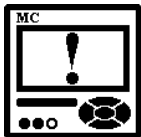

It is strongly advised to download recorder values before applying any changes to recorder or changes of settings for energy, type of connection, current and voltage transformer settings, used current and voltage ranges ...

These changes might have impact on recorded history so data might no longer be valid.

Recorders A and B setting

Separately, for each of the recorders, settings can be set:

Storage interval: sets a time interval for readings to be written to a recorder

Recorded quantities: for each of 16 measurements, which are to be recorded it is possible to set a required value and its representation within storage interval (minimum, maximum ...).

Parameter: here monitoring quantity can be selected from a list of supported measurements.

Value: representation of a value within set monitoring interval can be set to different conditions.

- Average value represents calculated average value
- Actual value represents value of recorded quantity at sampling intervals
- Minimum and Maximum value represents minimum or maximum of recorded quantity in selected storage interval. Minimum or maximum in this case represents averaged value according to average interval selected in *General settings* (see page 26).

Reset operations

Reset energy counters (E1, E2, E3, E4)

All or individual energy meters are reset.

 Main menu ⇒ Resets ⇒ Energy counters ⇒ All energy counters / Energy counter E1 / E2 / E3 / E4 OK

Reset maximal MD values

THERMAL MODE

Current and stored MDs are reset.

 Main menu ⇒ Resets ⇒ MD values ⇒

Reset the last MD period (MC350 and MC330 only)

THERMAL MODE

Current MD value is reset.

 Main menu ⇒ Resets ⇒ Last period MD ⇒

Alarm relay (1 or 2) Off (MC350 and MC330 only)

When using MiQen, each alarm output can be reset separately. On device (manually) only all alarm outputs together can be reset.

All alarms are reset.

 Main menu ⇒ Reset ⇒ Reset alarm output ⇒

Reset alarm statistic

Clears the alarm statistic that is evidenced since last power supply On.

MEASUREMENTS

INTRODUCTION.....	40
SUPPORTED MEASUREMENTS	40
AVAILABLE CONNECTIONS.....	40
EXPLANATION OF BASIC CONCEPTS	43
PRESENT VALUES	44
CALCULATION AND DISPLAY OF MEASUREMENTS	44
ALARMS.....	48
DEMONSTRATION MEASUREMENTS	48

Introduction

In the following chapters operation of the device is explained more in detail.

Supported measurements

Measurements support regarding the device type is described in chapter *Type differences*, pages 11. Selection of supported measurements of individual instrument type is changed with the connection settings.

Available connections

Different electric connections are described more in detail in chapter *Electric connection* on page 15. Connections are marked as follows:

- Connection 1b (1Wb) – Single phase connection
- Connection 3b (1W3b) – Three phase, three wire connection with balanced load
- Connection 4b (1W4b) – Three phase, four wire connection with balanced load
- Connection 3u (2W3u) – Three phase, three wire connection with unbalanced load
- Connection 4u (3W4u) – Tree phase, four wire connection with unbalanced load



PLEASE NOTE



Measurements support depends on connection mode and the device type.
Calculated measurements are only informative.

Survey of supported measurements regarding connection mode

All measurements, with designations can be displayed on customized screens.

	Basic measurements	Designat.	Unit	1b	3b	3u	4b	4u
Phase	Voltage U_1	U1	V	●	×	×	●	●
	Voltage U_2	U2	V	×	×	×	○	●
	Voltage U_3	U3	V	×	×	×	○	●
	Average voltage U_{\sim}	U_{λ}	V	×	×	×	○	●
	Current I_1	I1	A	●	●	●	●	●
	Current I_2	I2	A	×	○	●	○	●
	Current I_3	I3	A	×	○	●	○	●
	Current I_n	I _{nc}	A	×	○	○	○	●
	Total current I_t	I	A	●	○	○	○	●

Average current I_a	lavg	A	x	○	○	○	○	●
Active power P_1	P1	W	●	x	x	●	●	●
Active power P_2	P2	W	x	x	x	○	●	●
Active power P_3	P3	W	x	x	x	○	●	●
Total active power P_t	P	W	●	●	●	○	●	●
Reactive power Q_1	Q1	var	●	x	x	●	●	●
Reactive power Q_2	Q2	var	x	x	x	○	●	●
Reactive power Q_3	Q3	var	x	x	x	○	●	●
Total reactive power Q_t	Q	var	●	●	●	○	●	●

● - serial ○ - option x - not supported

	Basic measurements	Designat.	Unit	1b	3b	3u	4b	4u
Phase	Apparent power S_1	S1	VA	●	×	×	●	●
	Apparent power S_2	S2	VA	×	×	×	○	●
	Apparent power S_3	S3	VA	×	×	×	○	●
	Total apparent power S_t	S	VA	●	●	●	○	●
	Power factor PF_1	PF1/ePF1		●	×	×	●	●
	Power factor PF_2	PF2/ePF2		×	×	×	○	●
	Power factor PF_3	PF3/ePF3		×	×	×	○	●
	Total power factor PF^{\sim}	PF/ePF		●	●	●	○	●
	Power angle ϕ_1	ϕ_1	°	●	×	×	●	●
	Power angle ϕ_2	ϕ_2	°	×	×	×	○	●
	Power angle ϕ_3	ϕ_3	°	×	×	×	○	●
	Total power angle ϕ^{\sim}	ϕ	°	●	●	●	○	●
	THD of phase voltage U_{f1}	U1%	%THD	●	×	×	●	●
	THD of phase voltage U_{f2}	U2%	%THD	×	×	×	○	●
	THD of phase voltage U_{f3}	U3%	%THD	×	×	×	○	●
	THD of phase current I_1	I1%	%THD	●	●	●	●	●
THD of phase current I_2	I2%	%THD	×	○	●	○	●	
THD of phase current I_3	I3%	%THD	×	○	●	○	●	
Phase-to-phase	Phase-to-phase voltage U_{12}	U12	V	×	●	●	○	●
	Phase-to-phase voltage U_{23}	U23	V	×	●	●	○	●
	Phase-to-phase voltage U_{31}	U31	V	×	●	●	○	●
	Average phase-to-phase voltage (U_{ff})	U_{Δ}	V	×	●	●	○	●
	Phase-to-phase angle ϕ_{12}	ϕ_{12}	°	×	×	×	○	●
	Phase-to-phase angle ϕ_{23}	ϕ_{23}	°	×	×	×	○	●
	Phase-to-phase angle ϕ_{31}	ϕ_{31}	°	×	×	×	○	●
	THD of phase-to-phase voltage THD_{U12}	U12%	%THD	×	●	●	○	●
	THD of phase-to-phase voltage THD_{U23}	U23%	%THD	×	●	●	○	●
	THD of phase-to-phase voltage THD_{U31}	U31%	%THD	×	●	●	○	●
Energy	Counters 1-4	E1, E2	Wh VAh	●	●	●	●	●
	Active tariff	Atar		●	●	●	●	●
Max. values MD	MD current I_1	I1	A	●	●	●	●	●
	MD current I_2	I2	A	×	○	●	○	●
	MD current I_3	I3	A	×	○	●	○	●
	MD active power P (positive)	P+	W	●	●	●	●	●
	MD active power P (negative)	P-	W	●	●	●	●	●
	MD reactive power Q-L	Q_{L}	var	●	●	●	●	●
	MD reactive power Q-C	Q_{C}	var	●	●	●	●	●
MD apparent power S	S	VA	●	●	●	●	●	

● - serial ○ - option × - not supported



PLEASE NOTE



Basic and MD measurements have designations for recognition via LCD. In this way they can be selected via LCD for a display on customized screens.

WARNING!

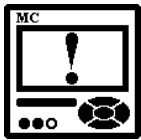

When, due to mode of connection, unsupported measurement is selected for customized screen an undefined value is displayed.

Explanation of basic concepts

Sample factor – M_V

A device measures all primary quantities with sample frequency which cannot exceed a certain number of samples in a time period. Based on these limitations (65 Hz·128 samples) a sample factor is calculated. A sample factor (M_V), depending on frequency of a measured signal, defines a number of periods for a measurement calculation and thus a number of harmonics considered in calculations.

Average interval – M_P

Due to readability of measurements from LCD and via communication, an Average interval (M_P) is calculated with regard to the measured signal frequency. The Average interval (see chapter *Average interval* on page 43) defines refresh rate of displayed measurements based on a sampling factor.

Power and energy flow

Figures below show a flow of active power, reactive power and energy for 4u connection.

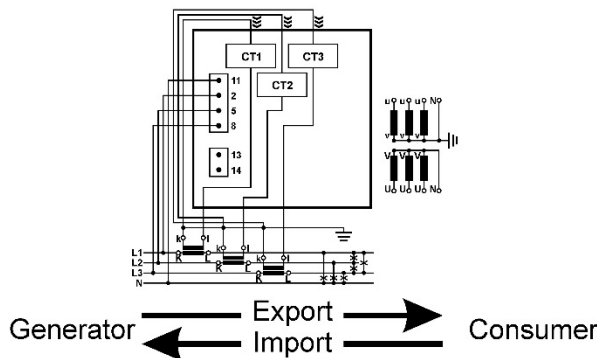
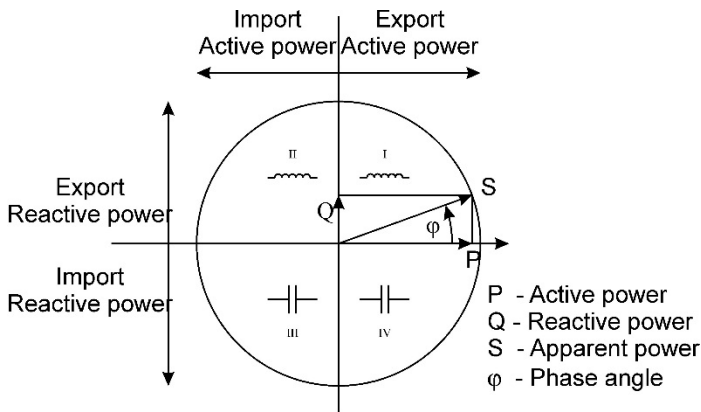

PLEASE NOTE



Display of energy flow direction can be adjusted to connection and operation requirements by changing the *Energy flow direction* settings in general / connection (see page 29).

Present values



PLEASE NOTE



Since measurement support depends on connection mode some display groups can be combined in to one, within Measurements menu.

Calculation and display of measurements

This chapter deals with capture, calculation and display of all supported quantities of measurement. Only the most important equations are described; however, all of them are shown in chapter *Equations* on page 69 with additional descriptions and explanations.



PLEASE NOTE



Calculation and display of measurements depend on the device type and connection used. For more detailed information see *chapters Survey of supported measurements regarding connection mode* on page 40.

For entry and quitting measurement display menu, the OK key is used. Direction keys (left / right / up / down) are used for passing between displays as show in example below.

Example for MC330 at 4u connection mode:



Main menu Main menu ⇒ Measurements ⇒ Present values ⇒ Voltage OK

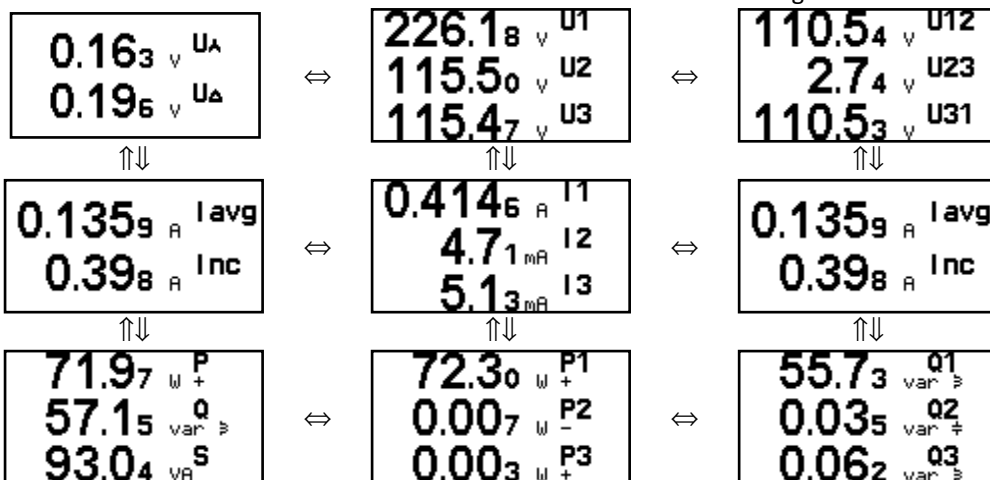

Voltage

Instrument measures real effective (trms) value of all phase voltages (U_1, U_2, U_3) connected to the meter. Phase-to-phase voltages (U_{12}, U_{23}, U_{31}), average phase voltage (U_f) and average phase-to-phase voltage (U_a) are calculated from measured phase voltages (U_1, U_2, U_3).

$$U_f = \sqrt{\frac{\sum_{n=1}^N u_n^2}{N}} \quad U_{xy} = \sqrt{\frac{\sum_{n=1}^N (u_{xn} - u_{yn})^2}{N}}$$

All voltage measurements are available via communication, serial and customized displays on LCD.

 Main menu \Rightarrow Measurements \Rightarrow Present values \Rightarrow Voltage OK

Current

The device measures real effective (trms) value of phase currents, connected to current inputs. Neutral current (I_n), average current (I_a) and a sum of all phase currents (I_t) are calculated from phase currents.

$$I_{TRMS} = \sqrt{\frac{\sum_{n=1}^N i_n^2}{N}}$$

All current measurements are available via communication, serial (except I_t) and customized displays on LCD.

 Main menu \Rightarrow Measurements \Rightarrow Present values \Rightarrow Current OK

Active, reactive and apparent power

Active power is calculated from instantaneous phase voltages and currents. All measurements are seen via communication or are displayed on LCD. For more detailed information about calculation see chapter *Equations* on page 69.

 Main menu \Rightarrow Measurements \Rightarrow Present values \Rightarrow Power OK

Power factor and power angle

Power angle is calculated as quotient of active and apparent power for each phase separately ($\cos\phi_1, \cos\phi_2, \cos\phi_3$) and total power angle ($\cos\phi_t$). A symbol for a coil represents inductive load and a symbol for a capacitor represents capacitive load. For correct display of PF via analogue output and application of the alarm, ePF (extended power factor) is applied. It illustrates power factor with one value as described in the table below. For a display on LCD both of them have equal display function: between -1 and +1 with the icon for inductive or capacitive load.

Load	C	\rightarrow		\leftarrow	L
Angle [°]	-180	-90	0	+90	+180 (179.99)
PF	-1	0	1	0	-1
ePF	-1	0	1	2	3

 Main menu \Rightarrow Measurements \Rightarrow Present values \Rightarrow PF & Power angle OK

Example of analogue output for PF and ePF (MC350 and MC350H only):

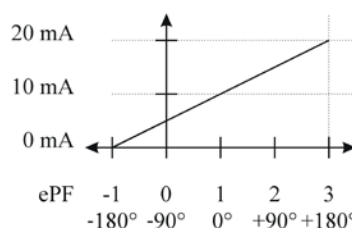
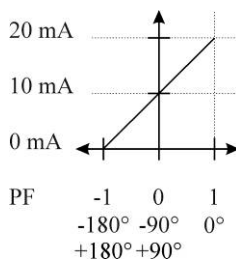

Power angle represents angle between first voltage harmonic and first current harmonic for each individual phase. Total power angle is calculated from total active and reactive power (see equation for Total power angle, chapter *Equations* on page 69). A positive sign shows inductive load, and a negative sign shows capacitive load.

Frequency

Network frequency is calculated from time periods of measured voltage.

 Main menu \Rightarrow Measurements \Rightarrow Present values \Rightarrow Frequency OK

Energy

Two ways of energy display are available: by individual meters and by tariffs for each meter separately. At a display of meter energy by tariffs, the sum in the upper line depends on the tariffs set in the meter.

 Main menu \Rightarrow Measurements \Rightarrow Present values \Rightarrow Energy OK

MD values

Display of MD values.

 Main menu \Rightarrow Measurements \Rightarrow Present values \Rightarrow MD values OK

THD - Total harmonic distortion

THD is calculated for phase currents, phase and phase-to-phase voltages and is expressed as percent of high harmonic components regarding TRMS value or relative to first harmonic.

Instrument uses measuring technique of real effective (trms) value that assures exact measurements with the presence of high harmonics up to 31st harmonic.

 Main menu \Rightarrow Measurements \Rightarrow Present values \Rightarrow THD OK

Customized screens

A display of customized screens depends on settings. See chapter *Settings of customized screens* on page 30.

 Main menu \Rightarrow Measurements \Rightarrow Present values \Rightarrow Custom OK

Overview

It combines several measurements on each display as the following screens are displayed:

 Explanation of measurements for MC330 at connection mode 4u:

SCREEN 1:

Current phase measurements			Current phase measurements		
U λ	Average voltage U \sim	V	P	Total active power P $_t$	W
1	Phase voltage U $_1$	V	P1	Active power P $_1$	W
2	Phase voltage U $_2$	V	P2	Active power P $_2$	W
3	Phase voltage U $_3$	V	P3	Active power P $_3$	W
I λ	Average current I \sim	A	Q	Total reactive power Q $_t$	var
1	Current I $_1$	A	Q1	Reactive power Q $_1$	var
2	Current I $_2$	A	Q2	Reactive power Q $_1$	var
3	Current I $_3$	A	Q3	Reactive power Q $_1$	var

SCREEN 2:

Current phase-to-phase measurements			Current phase-to-phase measurements		
U Δ	Average phase-to-phase U \sim	V	Frequency f		Hz
12	Phase-to-phase voltage U ₁₂	V	ϕ	Power angle ϕ_1	°
23	Phase-to-phase voltage U ₂₃	V	ϕ	Power angle ϕ_2	°
31	Phase-to-phase voltage U ₃₁	V	ϕ	Power angle ϕ_3	°
PF	Total power factor		ϕ	Average phase-to-phase angle ϕ	°
PF1	Power factor PF ₁		ϕ	Power angle ϕ_{12}	°
PF2	Power factor PF ₂		ϕ	Power angle ϕ_{23}	°
PF3	Power factor PF ₃		ϕ	Power angle ϕ_1	°

SCREEN 3:

Dynamic MD values				Maximal MD values			
P+	MD active power (positive)	P	W	MD active power P (positive)	P	W	
P-	MD active power (negative)	P	W	MD active power P (negative)	P	W	
Q \ominus	MD reactive power Q-L	var		MD reactive power Q-L	var		
Q \oplus	MD reactive power Q-C	var		MD reactive power Q-C	var		
S	MD apparent power S	VA		MD apparent power S	VA		
I1	MD current I1	A		MD current I1	A		
I2	MD current I2	A		MD current I2	A		
I3	MD current I3	A		MD current I3	A		

Example for MC350 at connection 4u:

Main menu \Rightarrow Measurements \Rightarrow Present values \Rightarrow Overview OK / \Rightarrow

U Δ 151.14 V P +78.00	U Δ 74.17 V 49.996 Hz	P+ = 64.933 4.4640kW
U Δ 124.43 V P1 +69.99	U Δ 109.90 V \$\$\$ -2.25	P- = 0.000 6.562 W
U Δ 114.57 V P2 -0.003	U Δ 109.74 V \$\$\$ +0.003	Q \ominus = 0.277 3.3265kvar
U Δ 114.57 V P3 +0.011	U Δ 109.57 V \$\$\$ +0.200	Q \oplus = 0.000 14.994kvar
U Δ 0.13 V P0 +0.011	U Δ 109.79 V \$\$\$ +0.001	S = 0.150 10.012 VA
U Δ 0.33 V P01 +0.000	U Δ 109.79 V \$\$\$ -0.000	I1 = 4.650 10.007 A
U Δ 0.33 V P02 -0.019	U Δ 109.79 V \$\$\$ -0.000	I2 = 4.650 10.007 A
U Δ 0.33 V P03 +0.124	U Δ 109.79 V \$\$\$ +0.000	I3 = 5.110 10.007 A

Alarms

An alarm menu enables surveying state of alarms. In the basic alarm menu, groups of alarms with the states of individual alarms and data on alarm outputs are displayed in the bottom line. For each active alarm a number of an alarm is written in a certain group at a certain place: Group 1: 1...45...8. Dot stands for alarm not active.

```

Measurements
Present values
Alarms
Demo cycling
Main menu
    
```

OK

```

Alarms
Group 1: 123...
Group 2: .....
Out 1
Measurements
    
```

OK

```

G1A1 U1 < 200.00
G1A2 U2 < 200.00
G1A3 U3 < 200.00
G1A4 U1 > 300.00
G1A5 U2 > 300.00
G1A6 U3 > 300.00
G1A7 --
G1A8 --
    
```

Survey of alarms

In a detailed survey alarms are collected in groups. A number of a group and alarm is stated in the first column, a measurement designation in the second, and a condition for alarm in the third one. Active alarm is marked.



Main menu ⇒ Measurements ⇒ Alarms OK / ⇒

Demonstration measurements

Demo cycling

Regarding the period that is defined in settings, measurement screen cycling is started until any key is pressed.



Main menu ⇒ Measurements ⇒ Demo cycling OK

TECHNICAL DATA

ACCURACY..... 49
 INPUTS 50
 CONNECTION 50
 MODULES 51
 COMMUNICATION..... 52
 ELECTRONIC FEATURES..... 52
 SAFETY FEATURES 53
 DIMENSIONS..... 54

Accuracy

Measured values	Range		Accuracy class*
Trms current ($I_1, I_2, I_3, I_{avg}, I_n$)	1 A		0.5
	5 A		0.5
Maximum current	12.5 A		0.5**
Trms phase voltage (U_1, U_2, U_3, U_{avg})	75 V _{L-N}		0.5
	120 V _{L-N}		0.5
	250 V _{L-N}		0.5
	500 V _{L-N}		0.5
Maximum voltage	600 V		0.5**
Trms phase-to-phase voltage ($U_{12}, U_{23}, U_{31}, U_{avg}$)	120 V _{L-L}		0.5
	210 V _{L-L}		0.5
	400 V _{L-L}		0.5
	800 V _{L-L}		0.5
Frequency (f) – actual	50 / 60 Hz		10 mHz
Nominal frequency range	16...400 Hz		0.02
Power angle (ϕ)	-180...0...180°		0.5°
Power factor (PF)	-1...0...+1		0.5
	U = 50 ... 120 % U_n I = 2 % ... 200 % I_n		
Maximal values (MD)	75	375	1.0
	120	600	
	250	1250	
	500	2500	
	[W/var/VA] $I_n = 1$ A	[W/var/VA] $I_n = 5$ A	
THD	5...500 V 0...400 %		0.5
Active power	75	375	0.5
Reactive power	120	600	
	Apparent power	250	1250
500		2500	
	[W/var/VA] $I_n = 1$ A	[W/var/VA] $I_n = 5$ A	0.5
Active energy	EN 62053-21		Class 1***
Active energy (optional)	EN 62053-22		Class 0.5S***
Reactive energy	EN 62053-23		Class 2***



PLEASE NOTE



* – All measurements are calculated with high harmonic signals. For voltage up to 65 Hz or less, harmonics up to 31st are measured.

** – From range

*** – Partial compliance

Inputs

Voltage input	Nominal voltage (U_n)	500 V_{L-N}	
	Rating	75 V_{L-N} / 250 V_{L-N} / 500 V_{L-N}	
	Overload	1.2 x U_n permanently	
	Minimal measurement	From starting voltage for all powers	
	Maximal measurement	600 V_{L-N}	
	Consumption	< 0.1 VA per phase	
	Current input	Nominal current (I_n)	5 A
Rating		1 A / 5 A	
Overload		3 x I_n permanently, 25 x I_n – 3 s, 50 x I_n – 1 s	
Minimal measurement		From starting current for all powers	
Maximal measurement		12,5 A sinusoidal	
Consumption		< 0.1 VA per phase	
Frequency		Nominal frequency (f_n)	50, 60 Hz
	Measuring range	16...400 Hz	
	Maximum range	10 Hz...1 kHz	
Supply	Universal	AC voltage range	48...276 V
		AC frequency range	40...65 Hz
		DC voltage range	20...300 V
		Consumption	< 5 VA
	AC	Voltage range	57.7, 63.5, 100, 110, 230, 240, 400, 500 V
		Frequency range	40...65 Hz
		Consumption	< 3 VA

Connection

Permitted conductor cross-sections

Terminals	Max. conductor cross-sections
Voltage inputs (4)	$\leq 2.5 \text{ mm}^2$
Current inputs (3)	$\leq \varnothing 6 \text{ mm}$ one conductor with insulation
Supply (2)	$\leq 2.5 \text{ mm}^2$
Modules (2 x 3)	$\leq 2.5 \text{ mm}^2$ one conductor

Modules

Relay output	<p>Purpose alarm, pulse, general purpose digital output</p> <p>Type Electromechanical Relay switch</p> <p>Rated voltage AC 250 V AC</p> <p>Max. switching current AC 1000 mA AC</p> <p>Rated voltage DC 250 V DC</p> <p>Max. switching current DC 200 mA DC (valid for resistive load)</p> <p>Contact resistance $\leq 100 \text{ m}\Omega$ (100 mA, 24 V)</p> <p>Pulse (if used as pulse output) Max. No.4000 imp/hour Min. length 100 ms</p> <p>Insulation voltage</p> <p>Between coil and contact 4 kV AC TRMS</p> <p>Between contacts 1 kV AC TRMS</p>
S0 (pulse) output	<p>Purpose pulse, alarm, general purpose digital output</p> <p>Type Optocoupler open collector switch</p> <p>Rated voltage 40 V AC/DC</p> <p>Max. switching current 30 mA ($R_{ONmax} = 8 \Omega$)</p> <p>Pulse length (if used as pulse output) programmable (2 ... 1000 ms)</p>
Tariff input module	<p>Rated voltage 230 V \pm 20 % AC/DC 75 ... 110 V AC/DC</p> <p>Max. current < 0.6 mA</p> <p>Frequency range 45 ... 65 Hz</p> <p>ON voltage 40 ... 120 % of rated voltage</p> <p>OFF voltage 0 ... 10 % of rated voltage</p>
Digital input module	<p>Rated voltage 230 V \pm 20 % AC/DC 75 ... 110 V AC/DC 24 V DC</p> <p>Max. current < 0.6 mA</p> <p>Frequency range 45 ... 65 Hz</p> <p>ON voltage 40 ... 120 % of rated voltage</p> <p>OFF voltage 0 ... 10 % of rated voltage</p>
Analogue output (MC350, MC350H, with aux. power supply type H only)	<p>Output range 0 ... 20 mA</p> <p>Accuracy 0.5 % of range</p> <p>Maximum load 150 Ω</p> <p>Max. voltage on output (open circuit current output) 5 V</p> <p>Linearization Linear, Quadratic</p> <p>Max. No. of break points 5</p> <p>Output value limits 120 % of nominal output</p> <p>Response time of analogue output Depends on set Average interval (8 – 256 periods)</p> <p>Residual ripple < 1 % p.p.</p>

Communication

	RS232	RS485	USB	Service USB	M-Bus
Type of connection	Direct	Network	Direct	Direct	Direct
Max. connection length	3 m	1000 m	5 m	5 m	1000 m
Terminals	3 pin connector		USB – B type	Mini USB – B type	3 pin connector
Insulation	In accordance with EN 61010-1 standard			Not galvanic insulated	Galvanic insulated
Transfer mode	Asynchronous				
Protocol	MODBUS RTU /DNP3			M-Bus –EN13757	
Transfer rate	2.400 to 115.200 bit/s		115.200 bit/s		300 to 9600 bit/s

Electronic features

LCD Type Size LCD refreshing	Graphic LCD 128 x 64 dots Every 200 ms
Response time Input – screen Input – communication Input – alarm	All calculations are averaged over an interval of between 8 to 256 periods. Present interval is 64 periods, which is 1.28 second at 50 Hz.
Memory (MC350 & MC350H only) Capacity Divisions Selection of limit values Sampling period	8 Mb built in flash Recorders A and B Alarms recorder Average, minimum, maximum actual 1 to 60 min
LED's Pulse output Alarm	Red Energy flow Red Fulfilled condition for alarm
RTC backup supply Supercap	Lifespan 2 days

Safety features

Safety	In compliance with EN 61010–1 600 V trms, installation category II 300 V trms, installation category III Pollution degree 2
Test voltage	3.7 kV rms,
EMC	Directive on electromagnetic compatibility 2014/30/EU In compliance with EN 61326-1
Protection	In compliance with EN 60529 Front side: IP52 Rear side (with protection cover): IP20
Ambient conditions	
Temperature range of operation	–10 to +60°C
Storage temperature range	–40 to +70°C
Max. storage and transport humidity	≤ 75% r.h.
Enclosure	
Material	PC, incombustibility – self-extinguishability, in compliance with UL 94 V0
Weight	Max. 500 g

Dimensions

CASING

Construction	Appearance
	All dimensions are in mm

PANEL CUT OUT

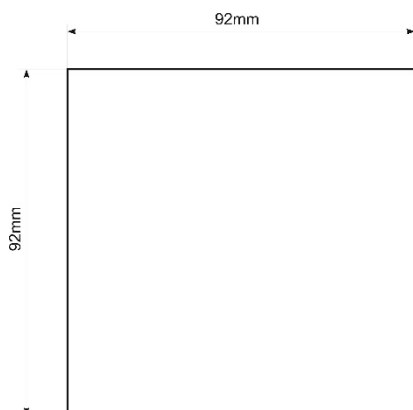

APPENDIX A: MODBUS PROTOCOL

Modbus communication protocol

Modbus and DNP3 protocol are enabled via RS232 or RS485 or USB communication port. The response is the same type as the request.

Modbus protocol

Modbus protocol enables operation of device on Modbus networks. For device with serial communication the Modbus protocol enables point to point (for example Device to PC) communication via RS232 communication and multi drop communication via RS485 communication. Modbus protocol is a widely supported open interconnect originally designed by Modicon.

The memory reference for input and holding registers is 30000 and 40000 respectively.

At MODBUS register 40100 (MODBUS table for measurements) you can select register map. Value "0" is MC7X0 compatible register map. Value "1" is MI71X0 compatible register map.

Register table for the actual measurements

Parameter	Type	MC7x0 RM Comp.		MI71x0 RM Comp.	
		Start	End	Start	End
Voltage U_1	T5	30107	30108	30044	30045
Voltage U_2	T5	30109	30110	30046	30047
Voltage U_3	T5	30111	30112	30048	30049
Average phase Voltage U_{\sim}	T5	30113	30114	30042	30043
Phase to phase voltage U_{12}	T5	30118	30119	30081	30082
Phase to phase voltage U_{23}	T5	30120	30121	30083	30084
Phase to phase voltage U_{31}	T5	30122	30123	30085	30086
Avg. phase to phase Voltage $U_{pp\sim}$	T5	30124	30125	30079	30080
Current I_1	T5	30126	30127	30036	30037
Current I_2	T5	30128	30129	30038	30039
Current I_3	T5	30130	30131	30040	30041
Total Current I	T5	30138	30139	30034	30035
Neutral current I_n	T5	30132	30133	30074	30075
Real Power P_1	T6	30142	30143	30020	30021
Real Power P_2	T6	30144	30145	30022	30023
Real Power P_3	T6	30146	30147	30024	30025
Total Real Power P	T6	30140	30141	30018	30019
Reactive Power Q_1	T6	30150	30151	30028	30029
Reactive Power Q_2	T6	30152	30153	30030	30031
Reactive Power Q_3	T6	30154	30155	30032	30033
Total Reactive Power Q	T5	30148	30149	30026	30027
Apparent Power S_1	T5	30158	30159	30052	30053
Apparent Power S_2	T5	30160	30161	30054	30055
Apparent Power S_3	T5	30162	30163	30056	30057
Total Apparent Power S	T7	30156	30157	30050	30051

Parameter	Type	MC7x0 RM Comp.		MI71x0 RM Comp.	
		Start	End	Start	End
Power Factor PF ₁	T7	30166	30167	30060	30061
Power Factor PF ₂	T7	30168	30169	30062	30063
Power Factor PF ₃	T7	30170	30171	30064	30065
Total Power Factor PF	T7	30164	30165	30058	30059
Power Angle U ₁ -I ₁	T2	30173		30071	
Power Angle U ₂ -I ₂	T2	30174		30072	
Power Angle U ₃ -I ₃	T2	30175		30073	
Power Angle atan2(Pt, Qt)	T2	30172		30070	
Angle U ₁ -U ₂	T2	30115		30076	
Angle U ₂ -U ₃	T2	30116		30077	
Angle U ₃ -U ₁	T2	30117		30078	
Frequency f	T5	30105	30106		
Frequency f (mHz)	T1			30066	
THD I ₁	T1	30188		30118	
THD I ₂	T1	30189		30119	
THD I ₃	T1	30190		30120	
THD U ₁	T1	30182		30112	
THD U ₂	T1	30183		30113	
THD U ₃	T1	30184		30114	
THD U ₁₂	T1	30185		30115	
THD U ₂₃	T1	30186		30116	
THD U ₃₁	T1	30187		30117	
Max Demand Since Last RESET					
MD Real Power P (positive)	T6	30542	30543		
MD Real Power P (negative)	T6	30548	30549		
MD Reactive Power Q – L	T6	30554	30555		
MD Reactive Power Q – C	T6	30560	30561		
MD Apparent Power S	T5	30536	30537		
MD Current I ₁	T5	30518	30519		
MD Current I ₂	T5	30524	30525		
MD Current I ₃	T5	30530	30531		
Dynamic Demand Values					
MD Real Power P (positive)	T6	30510	30511		
MD Real Power P (negative)	T6	30512	30513		
MD Reactive Power Q – L	T6	30514	30515		
MD Reactive Power Q –	T6	30516	30517		
MD Apparent Power S	T5	30508	30509		
MD Current I ₁	T5	30502	30503		
MD Current I ₂	T5	30504	30505		
MD Current I ₃	T5	30506	30507		
Energy					
Energy Counter 1 Exponent	T2	30401		30006	
Energy Counter 2 Exponent	T2	30402		30007	
Energy Counter 3 Exponent	T2	30403		30008	
Energy Counter 4 Exponent	T2	30404		30009	

Parameter	Type	MC7x0 RM Comp.		MI71x0 RM Comp.	
		Start	End	Start	End
Counter E1	T3	30406	30407	30010	30011
Counter E2	T3	30408	30409	30012	30013
Counter E3	T3	30410	30411	30014	30015
Counter E4	T3	30412	30413	30016	30017
Active tariff	T1	30405		30133	
Internal Temperature	T17	30181		30128	

Register table for the normalized actual measurements

Parameter	MODBUS		100% value
	Register	Type	
Voltage U_1	30801	T16	Un
Voltage U_2	30802	T16	Un
Voltage U_3	30803	T16	Un
Average phase Voltage U_{\sim}	30804	T16	Un
Phase to phase voltage U_{12}	30805	T16	Un
Phase to phase voltage U_{23}	30806	T16	Un
Phase to phase voltage U_{31}	30807	T16	Un
Average phase to phase Voltage	30808	T16	Un
Current I_1	30809	T16	In
Current I_2	30810	T16	In
Current I_3	30811	T16	In
Total Current I	30812	T16	It
Neutral current I_n	30813	T16	In
Average Current I_{\sim}	30815	T16	In
Real Power P_1	30816	T17	Pn
Real Power P_2	30817	T17	Pn
Real Power P_3	30818	T17	Pn
Total Real Power P	30819	T17	Pt
Reactive Power Q_1	30820	T17	Pn
Reactive Power Q_2	30821	T17	Pn
Reactive Power Q_3	30822	T17	Pn
Total Reactive Power Q	30823	T17	Pt
Apparent Power S_1	30824	T16	Pn
Apparent Power S_2	30825	T16	Pn
Apparent Power S_3	30826	T16	Pn
Total Apparent Power S	30827	T16	Pt
Power Factor PF_1	30828	T17	1
Power Factor PF_2	30829	T17	1
Power Factor PF_3	30830	T17	1
Total Power Factor PF	30831	T17	1
CAP/IND P.F. Phase 1 (PF_1)	30832	T17	1
CAP/IND P.F. Phase 2 (PF_2)	30833	T17	1
CAP/IND P.F. Phase 3 (PF_3)	30834	T17	1
CAP/IND P.F. Total (PF_t)	30835	T17	1

Parameter	MODBUS		100% value
	Register	Type	
Power Angle U_1-I_1	30836	T17	100°
Power Angle U_2-I_2	30837	T17	100°
Power Angle U_3-I_3	30838	T17	100°
Power Angle $\text{atan } 2(\text{Pt}, \text{Qt})$	30839	T17	100°
Angle U_1-U_2	30840	T17	100°
Angle U_2-U_3	30841	T17	100°
Angle U_3-U_1	30842	T17	100°
Frequency	30843	T17	$F_n+10\text{Hz}$
THD I_1	30845	T16	100%
THD I_2	30846	T16	100%
THD I_3	30847	T16	100%
THD U_1	30848	T16	100%
THD U_2	30849	T16	100%
THD U_3	30850	T16	100%
THD U_{12}	30851	T16	100%
THD U_{23}	30852	T16	100%
THD U_{31}	30853	T16	100%
Max Demand Since Last Reset			
MD Real Power P (positive)	30854	T16	Pt
MD Real Power P (negative)	30855	T16	Pt
MD Reactive Power Q – L	30856	T16	Pt
MD Reactive Power Q – C	30857	T16	Pt
MD Apparent Power S	30858	T16	Pt
MD Current I_1	30859	T16	In
MD Current I_2	30860	T16	In
MD Current I_3	30861	T16	In
Dynamic Demand Values			
MD Real Power P (positive)	30862	T16	Pt
MD Real Power P (negative)	30863	T16	Pt
MD Reactive Power Q – L	30864	T16	Pt
MD Reactive Power Q – C	30865	T16	Pt
MD Apparent Power S	30866	T16	Pt
MD Current I_1	30867	T16	In
MD Current I_2	30868	T16	In
MD Current I_3	30869	T16	In
Energy			
Energy Counter 1	30870	T17	Actual counter value MOD 20000 is returned
Energy Counter 2	30871	T17	
Energy Counter 3	30872	T17	
Energy Counter 4	30873	T17	
Active Tariff	30879	T1	
Internal Temperature	30880	T17	100°

100% values calculations for normalized measurements

Un =	(R40147 / R40146) * R30015 * R40149
In =	(R40145 / R40144) * R30017 * R40148
Pn =	Un*In
It =	In Connection Mode: 1b
It =	3*In Connection Modes: 3b, 4b, 3u, 4u
Pt =	Pn Connection Mode: 1b
Pt =	3*Pn Connection Modes: 3b, 4b, 3u, 4u
Fn =	R40150

Register	Content
30015	Calibration voltage
30017	Calibration current

Register table for the basic settings

Register	Content	Type	Ind	Values / Dependencies	Min	Max	P. Level
40143	Connection Mode	T1	0	No mode	1	5	2
			1	1b - Single Phase			
			2	3b - 3 phase 3 wire balanced			
			3	4b - 3 phase 4 wire balanced			
			4	3u - 3 phase 3 wire unbalanced			
			5	4u - 3 phase 4 wire unbalanced			
40144	CT Secondary	T4		mA			2
40145	CT Primary	T4		A/10			2
40146	VT Secondary	T4		mV			2
40147	VT Primary	T4		V/10			2
40148	Current input range (%)	T16		10000 for 100%	5,00	200,00	2
40149	Voltage input range (%)	T16		10000 for 100%	2,50	100,00	2
40150	Frequency nominal value	T1		Hz	10	1000	2

Data types decoding

Type	Bit mask	Description
T1		Unsigned Value (16 bit) Example: 12345 = 3039(16)
T2		Signed Value (16 bit) Example: -12345 = CFC7(16)
T3		Signed Long Value (32 bit) Example: 123456789 = 075B CD 15(16)
T4	bits # 15...14 bits # 13...00	Short Unsigned float (16 bit) Decade Exponent(Unsigned 2 bit) Binary Unsigned Value (14 bit) Example: 10000*102 = A710(16)
T5	bits # 31...24 bits # 23...00	Unsigned Measurement (32 bit) Decade Exponent(Signed 8 bit) Binary Unsigned Value (24 bit) Example: 123456*10-3 = FD01 E240(16)
T6	bits # 31...24 bits # 23...00	Signed Measurement (32 bit) Decade Exponent (Signed 8 bit) Binary Signed value (24 bit) Example: - 123456*10-3 = FDFE 1DC0(16)
T7	bits # 31...24 bits # 23...16 bits # 15...00	Power Factor (32 bit) Sign: Import/Export (00/FF) Sign: Inductive/Capacitive (00/FF) Unsigned Value (16 bit), 4 decimal places Example: 0.9876 CAP = 00FF 2694(16)
T9	bits # 31...24 bits # 23...16 bits # 15...08 bits # 07...00	Time (32 bit) 1/100s 00 - 99 (BCD) Seconds 00 - 59 (BCD) Minutes 00 - 59 (BCD) Hours 00 - 24 (BCD) Example: 15:42:03.75 = 7503 4215(16)
T10	bits # 31...24 bits # 23...16 bits # 15...00	Date (32 bit) Day of month 01 - 31 (BCD) Month of year 01 - 12 (BCD) Year (unsigned integer) 1998..4095 Example: 10, SEP 2000 = 1009 07D0(16)
T16		Unsigned Value (16 bit), 2 decimal places Example: 123.45 = 3039(16)
T17		Signed Value (16 bit), 2 decimal places Example: -123.45 = CFC7(16)
T_Str4		Text: 4 characters (2 characters for 16 bit register)
T_Str6		Text: 6 characters (2 characters for 16 bit register)
T_Str8		Text: 8 characters (2 characters for 16 bit register)
T_Str16		Text: 16 characters (2 characters for 16 bit register)
T_Str40		Text: 40 characters (2 characters for 16 bit register)

APPENDIX B: DNP3 COMMUNICATION PROTOCOL

DNP3 communication protocol

Modbus and DNP3 protocol are enabled via RS232 or RS485 or USB communication port. The response is the same type as the request.

DNP3

DNP3 protocol enables operation of device on DNP3 networks. For device with serial communication the DNP3 protocol enables point to point (for example Device to PC) communication via RS232 communication and multi drop communication via RS485 communication.

Object			Request		Response	
Object Number	Variation Number	Description	Function Codes (dec)	Qualifier Codes (hex)	Function Codes (dec)	Qualifier Codes (hex)
0	242	Device Attributes - software version	1	00	129	00, 17
0	243	Device Attributes – hardware version	1	00	129	00, 17
0	246	Device Attributes – user assigned ID	1	00	129	00, 17
0	248	Device Attributes – serial number	1	00	129	00, 17
0	250	Device Attributes – product name	1	00	129	00, 17
0	252	Device Attributes – manufacture name	1	00	129	00, 17
0	254	Device Attributes – nonspecific all attributes request	1	00, 06		
0	255	Device Attributes – list of attribute variation	1	00, 06	129	00, 5B

Points for object 0						
0	Software version	T_Str3	Data	var	242	
0	Hardware version	T_Str2	Data	var	243	
0	user assigned ID	T_Str2	Data	var	246	
0	serial number	T_Str8	Data	var	248	
0	product name	T_Str16	Data	var	250	
0	manufacture name	T_Str20	Data	var	252	

Object			Request		Response	
Object Number	Variation Number	Description	Function Codes (dec)	Qualifier Codes (hex)	Function Codes (dec)	Qualifier Codes (hex)
10	0	Binary output status with flag	1	6		
10	2	Binary output status with flag	1	00, 01 ,06	129	00, 01

Points for object 10						
----------------------	--	--	--	--	--	--

0	Relay 1	T1	Data	0	1	
1	Relay 2	T1	Data	0	1	

Register table for the actual measurements

Object			Request		Response	
Object Number	Variation Number	Description	Function Codes (dec)	Qualifier Codes (hex)	Function Codes (dec)	Qualifier Codes (hex)
30	0	16-Bit Analog Input without flag	1	00, 01, 06		
30	2	16-Bit Analog Input with flag	1	00, 01, 06	129	00, 01
30	4	16-Bit Analog Input without flag	1	00, 01, 06	129	00, 01

Points for object 30						
0	U1	T16	Data	-Un	+Un	
1	U2	T16	Data	-Un	+Un	
2	U3	T16	Data	-Un	+Un	
3	Uavg (phase to neutral)	T16	Data	-Un	+Un	
4	U12	T16	Data	-Un	+Un	
5	U23	T16	Data	-Un	+Un	
6	U31	T16	Data	-Un	+Un	
7	Uavg (phase to phase)	T16	Data	-Un	+Un	
8	I1	T16	Data	-In	+In	
9	I2	T16	Data	-In	+In	
10	I3	T16	Data	-In	+In	
11	I total	T16	Data	-In	+In	
12	I neutral (calculated)	T16	Data	-In	+In	
13	I neutral (measured)	T16	Data	-In	+In	
14	Iavg	T16	Data	-In	+In	
15	Active Power Phase L1 (P1)	T17	Data	-Pn	+Pn	
16	Active Power Phase L2 (P2)	T17	Data	-Pn	+Pn	
17	Active Power Phase L3 (P3)	T17	Data	-Pn	+Pn	
18	Active Power Total (Pt)	T17	Data	-Pt	+Pt	
19	Reactive Power Phase L1 (Q1)	T17	Data	-Pn	+Pn	
20	Reactive Power Phase L2 (Q2)	T17	Data	-Pn	+Pn	
21	Reactive Power Phase L3 (Q3)	T17	Data	-Pn	+Pn	
22	Reactive Power Total (Qt)	T17	Data	-Pt	+Pt	
23	Apparent Power Phase L1 (S1)	T16	Data	-Pn	+Pn	
24	Apparent Power Phase L2 (S2)	T16	Data	-Pn	+Pn	
25	Apparent Power Phase L3 (S3)	T16	Data	-Pn	+Pn	
26	Apparent Power Total (St)	T16	Data	-Pt	+Pt	
27	Power Factor Phase 1 (PF1)	T17	Data	-1	+1	
28	Power Factor Phase 2 (PF2)	T17	Data	-1	+1	
29	Power Factor Phase 3 (PF3)	T17	Data	-1	+1	
30	Power Factor Total (PFt)	T17	Data	-1	+1	
31	CAP/IND P. F. Phase 1 (PF1)	T17	Data	-1 CAP	+1	300% for -1 IND
32	CAP/IND P. F. Phase 2 (PF2)	T17	Data	-1 CAP	+1	300% for -1 IND
33	CAP/IND P. F. Phase 3 (PF3)	T17	Data	-1 CAP	+1	300% for -1 IND
34	CAP/IND P. F. Total (PFt)	T17	Data	-1 CAP	+1	300% for -1 IND
35	j1 (angle between U1 and I1)	T17	Data	-100°	+100°	
36	j2 (angle between U2 and I2)	T17	Data	-100°	+100°	

37	j3 (angle between U3 and I3)	T17	Data	-100°	+100°	
38	Power Angle Total (atan2(Pt,Qt))	T17	Data	-100°	+100°	
39	j12 (angle between U1 and U2)	T17	Data	-100°	+100°	
40	j23 (angle between U2 and U3)	T17	Data	-100°	+100°	
41	j31 (angle between U3 and U1)	T17	Data	-100°	+100°	
42	Frequency	T17	Data	Fn-10Hz	Fn+10Hz	
43	U unbalance	T16	Data	-100%	+100%	
44	I1 THD%	T16	Data	-100%	+100%	
45	I2 THD%	T16	Data	-100%	+100%	
46	I3 THD%	T16	Data	-100%	+100%	
47	U1 THD%	T16	Data	-100%	+100%	
48	U2 THD%	T16	Data	-100%	+100%	
49	U3 THD%	T16	Data	-100%	+100%	
50	U12 THD%	T16	Data	-100%	+100%	
51	U23 THD%	T16	Data	-100%	+100%	
52	U31 THD%	T16	Data	-100%	+100%	
	MAX DEMAND SINCE LAST RESET					
53	Active Power Total (Pt) - (positive)	T16	Data	-Pt	+Pt	
54	Active Power Total (Pt) - (negative)	T16	Data	-Pt	+Pt	
55	Reactive Power Total (Qt) - L	T16	Data	-Pt	+Pt	
56	Reactive Power Total (Qt) - C	T16	Data	-Pt	+Pt	
57	Apparent Power Total (St)	T16	Data	-Pt	+Pt	
58	I1	T16	Data	-In	+In	
59	I2	T16	Data	-In	+In	
60	I3	T16	Data	-In	+In	
	DYNAMIC DEMAND VALUES					
61	Active Power Total (Pt) - (positive)	T16	Data	-Pt	+Pt	
62	Active Power Total (Pt) - (negative)	T16	Data	-Pt	+Pt	
63	Reactive Power Total (Qt) - L	T16	Data	-Pt	+Pt	
64	Reactive Power Total (Qt) - C	T16	Data	-Pt	+Pt	
65	Apparent Power Total (St)	T16	Data	-Pt	+Pt	
66	I1	T16	Data	-In	+In	
67	I2	T16	Data	-In	+In	
68	I3	T16	Data	-In	+In	
	ENERGY					
69	Energy Counter 1	T17	Data			(32-bit value) MOD
70	Energy Counter 2	T17	Data			(32-bit value) MOD
71	Energy Counter 3	T17	Data			(32-bit value) MOD
72	Energy Counter 4	T17	Data			(32-bit value) MOD
73	Energy Counter 1 Cost	T17	Data			(32-bit value) MOD
74	Energy Counter 2 Cost	T17	Data			(32-bit value) MOD
75	Energy Counter 3 Cost	T17	Data			(32-bit value) MOD
76	Energy Counter 4 Cost	T17	Data			(32-bit value) MOD
77	Total Energy Counter Cost	T17	Data			(32-bit value) MOD
78	Aktiv Tariff	T1	Data			
79	Internal Temperature	T17	Data	-100°	+100°	

Object			Request		Response	
Object Number	Variation Number	Description	Function Codes (dec)	Qualifier Codes (hex)	Function Codes (dec)	Qualifier Codes (hex)
60	1	CLASS 0 DATA	1	6		
60	2	CLASS 1 DATA	1.22*	06		
60	3	CLASS 2 DATA	1.22*	06		
60	4	CLASS 3 DATA	1.22*	06		

*only object 30

Tests:

- Invalid start octets
- Invalid primary function code
- Invalid destination address
- Invalid CRC
- Invalid FCV

APPENDIX C: M-BUS

The M-BUS interface fully complies with M-BUS European standard EN13757-2. The entire communication is ensured with 8 Data Bits, Even Parity, 1 Stop Bit and a Baud Rate from 300 to 9600 Bauds.

Communication settings

The M-Bus communication settings could be done via LCD screen. In Main menu select Settings and then Communication. The LCD screen will show the following picture:

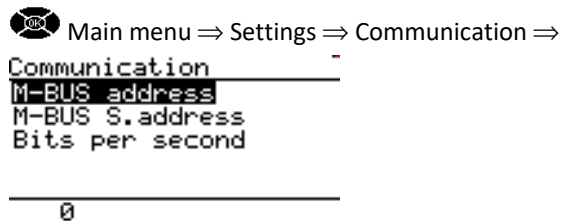

- M-BUS address represents primary address that is default set to 0. The primary address could takes numbers from 0 to 250. Higher address is used for special propose.
- M-BUS S.address represents secondary address that is default set to serial number of device. The secondary address could be any 8 digits number.
- Bits per seconds represent Baud rate of communication and could be in range from 300Bd to 9600Bd

Command telegrams

Initialize M-Bus (SNK_NKE)

This Short Telegram initializes the M-BUS MC350. The M-BUS MC350 confirms correct receipt by Single Character Acknowledgement (ACK = E5). If the telegram was not correctly received the MC350 will not send an acknowledgement.

Select M-BUS MC350 Using Secondary Address (SND_UD)

This Telegram enables to select M-BUS MC350. The M-BUS MC350 confirms the correct receipt by ACK. If the telegram has not been correctly received the M-BUS MC350 will not send an Acknowledgement. After issue of the Single Character Acknowledgement the M-BUS MC350 is ready to transmit the entire Read-out Data within 3 seconds from receiving the Telegram „Transmit Read-out Data“. At the end of 3 seconds the M-BUS MC350 will switch back to normal mode.

Transmit Read-out Data via Primary / Secondary Address (REQ_UD2)

This Short Telegram enables to select the M-BUS MC350 and to command it to transmit the Read-out Data parameterized. The M-BUS MC350 confirms correct receipt by transmitting of the Read-out Data. If the Short Telegram has not been received correctly; no Data will be transmitted by the M-BUS MC350. The Read-out Data are sent within 35 – 75 ms from receipt of the Short Telegram by the M-BUS Meter. **Appendix D** shows M-Bus telegrams.

Set Baud Rate via Primary / Secondary Address (SND_UD)

This telegram enables to set the desired Baud Rate. The M-BUS MC350 confirms the correct receipt by ACK. If the telegram was not received correctly the M-BUS MC350 does not send an Acknowledgement. The (ACK) is sent by the M-BUS MC350 in the Old Baud Rate. As soon as ACK is transmitted the M-BUS Meter switches to the baud rate newly parameterized. If the MC350 now does not receive a new Telegram under the new baud rate within a period of 30 – 40 seconds, it automatically switches back to the old baud rate. This is apt to prevent that a faulty setting of the baud rate may interrupt communication.

Set Primary Address via Primary / Secondary Address (SND_UD)

This Telegram enables to set a new Primary Address. The M-BUS MC350 confirms the correct receipt by ACK. If the telegram has not been correctly received the M-BUS MC350 will not send an Acknowledgement.

Set Secondary Address via Primary / Secondary Address (SND_UD)

This Telegram enables to set a new Secondary Address. The M-BUS MC350 confirms the correct receipt by ACK. If the telegram has not been correctly received the M-BUS MC350 will not send an Acknowledgement.

Secondary Address (UD) consists of:

- Identification Number: 00000000 – 99999999 8-digit Secondary Address number
- Manufacturer's Code: 73 26 2 Byte Company Constant (Iskra = "73 26")
- Version Number: 01 – FF 1 Byte
- Medium: 02 1 Byte Constant Electricity

Reset, Restart M-BUS MC350 via Primary / Secondary Address (SND_UD)

This Telegram resets / restarts M-BUS MC350. The M-BUS MC350 confirms correct receipt by ACK. If the telegram was not correctly received the M-BUS MC350 will not send an acknowledgement.

M-Bus Telegrams

Total Energy counters 0,1,2,3

Energy counters could represent: +/- active energy, +/-reactive energy or apparent energy and one of 4-th tariff.

	DIF	DIFE	DIFE	VIF	VIFE	VIFE	VIFE	DATA
								XX.XX.XX.XX
T0:	04	none	none					
T1:	84	10	none					
T2:	84	20	none					
T3:	84	30	none					
T4:	84	80	10					
A+:				0n	none	none	none	*10 ⁿ⁻³ Wh
A-:				8n	3C	none	none	*10 ⁿ⁻³ Wh
R+:				FB	82	7n	none	*10 ⁿ⁻³ varh
R-:				FB	82	Fn	3C	*10 ⁿ⁻³ varh
App:				FB	84	7n	none	*10 ⁿ⁻³ VAh

n - 0...7

Active Tariff number

Tariff number in progress (1 to 4)

	DIF	DIFE	DIFE	VIF	VIFE	VIFE	VIFE	DATA
	01			FF	01			xx

DATA: value represent as 8-bit integer

Active Power Total Pt (W)

Active power total in 32bit $\times 10^{(nnn-3)}W$

	DIF	DIFE	DIFE	VIF	VIFE	DATA
	04			0010 1nnn _b		xx.xx.xx.xx

n - 0...7

Reactive Power Total (kvar)

Reactive power total in 32bit $\times 10^{(nnn-3)}var$

	DIF	DIFE	VIF	VIFE	VIFE	VIFE	DATA
	04		FB	97	0111 0nnn _b		xx.xx.xx.xx

n - 0...7

Instant Apparent Power Total (VA)

Apparent power total in 32bit $\times 10^{(nnn-6)}VA$

	DIF	DIFE	VIF	VIFE	VIFE	VIFE	DATA
	04		FB	B4	0111 0nnn _b		xx.xx.xx.xx

n - 0...7

Power Factor: -: leading et +: lagging: PF

Power factor as 32-bit integer $\times 10^{-3}$

	DIF	DIFE	DIFE	VIF	VIFE	VIFE	VIFE	DATA
	04			A8	B4	35		xx.xx.xx.xx

Unit : W/V/A

Current Total (A)

Total current as 32bit $\times 10^{(nnnn-12)}A$

	DIF	DIFE	VIF	VIFE	VIFE	DATA
	04		FD	0101 nnnn _b		xx.xx.xx.xx

n - 0...15

System frequency (Hz/1000)

Contains the line frequency 32-bit integer in mHz.

	DIF	DIFE	DIFE	VIF	VIFE	VIFE	VIFE	DATA
	04			FB	2C			xx.xx.xx.xx

Active Power in Phase 1,2,3 (W)

Active power in 32bit $\times 10^{(nnn-3)}W$

	DIF	DIFE	DIFE	VIF	VIFE	VIFE	DATA
	04						xx.xx.xx.xx

P1:				1010 1nnn _b	FC	01	
P2:				1010 1nnn _b	FC	02	
P3:				1010 1nnn _b	FC	03	

n - 0...7

Current in Phase 1,2,3, Neutral (A)

Phase current as 32bit $\times 10^{(nnnn-12)}$ A

	DIF	DIFE	VIF	VIFE	VIFE	VIFE	DATA
	04						xx.xx.xx.xx
I1:			FD	1101 nnnn _b	FC	01	
I2:			FD	1101 nnnn _b	FC	02	
I3:			FD	1101 nnnn _b	FC	03	
In:			FD	1101 nnnn _b	FC	04	

n - 0...15

Voltages (V)

Voltage as 32bit $\times 10^{(nnnn-9)}$ V

	DIF	DIFE	VIF	VIFE	VIFE	VIFE	DATA
	04						xx.xx.xx.xx
U1:			FD	1100 nnnn _b	FC	01	
U2:			FD	1100 nnnn _b	FC	02	
U3:			FD	1100 nnnn _b	FC	03	
U12:			FD	1100 nnnn _b	FC	05	
U23:			FD	1100 nnnn _b	FC	06	
U31:			FD	1100 nnnn _b	FC	07	

n - 0...15

APPENDIX D: CALCULATIONS & EQUATIONS

Calculations

Definitions of symbols

No	Symbol	Definition
1	M_v	Sample factor
2	M_p	Average interval
3	U_f	Phase voltage (U1, U2 or U3)
4	U_{ff}	Phase-to-phase voltage (U12, U23 or U31)
5	N	Total number of samples in a period
6	n	Sample number ($0 \leq n \leq N$)
7	x, y	Phase number (1, 2 or 3)
8	i_n	Current sample n
9	u_{fn}	Phase voltage sample n
10	u_{ffn}	Phase-to-phase voltage sample n
11	ϕ_f	Power angle between current and phase voltage f (ϕ_1, ϕ_2 or ϕ_3)

Equations

Voltage

$$U_f = \sqrt{\frac{\sum_{n=1}^N u_n^2}{N}}$$

Phase voltage

N - 128 samples in one period (up to 65 Hz)

N - 128 samples in M_v periods (above 65Hz)

Example: 400 Hz $\rightarrow M_v = 7$

$$U_{xy} = \sqrt{\frac{\sum_{n=1}^N (u_{xn} - u_{yn})^2}{N}}$$

Phase-to-phase voltage

u_x, u_y - phase voltages (U_f)

N - a number of samples in a period

Current

$I_{\text{TRMS}} = \sqrt{\frac{\sum_{n=1}^N i_n^2}{N}}$	Phase current N - 128 samples in a period (up to 65 Hz) N - 128 samples in more periods (above 65 Hz)
$I_n = \sqrt{\frac{\sum_{n=1}^N (i_{1n} + i_{2n} + i_{3n})^2}{N}}$	Neutral current i - n sample of phase current (1, 2 or 3) N - 128 samples in a period (up to 65 Hz)

Power

$P_f = \frac{1}{N} \sum_{n=1}^N (u_{fn} \cdot i_{fn})$	Active power by phases N - a number of periods n - index of sample in a period f - phase designation
$P_t = P_1 + P_2 + P_3$	Total active power t - total power 1, 2, 3 - phase designation
$\text{Sign}Q_f(\varphi)$ $\varphi \in [0^\circ - 180^\circ] \rightarrow \text{Sign}Q_f(\varphi) = +1$ $\varphi \in [180^\circ - 360^\circ] \rightarrow \text{Sign}Q_f(\varphi) = -1$	Reactive power sign Q _f - reactive power (by phases) φ - power angle
$S_f = U_f \cdot I_f$	Apparent power by phases U _f - phase voltage I _f - phase current
$S_t = S_1 + S_2 + S_3$	Total apparent power S _f - apparent power by phases
$Q_f = \text{Sign}Q_f(\varphi) \cdot \sqrt{S_f^2 - P_f^2}$	Reactive power by phases S _f - apparent power by phases P _f - active power by phases
$Q_t = Q_1 + Q_2 + Q_3$	Total reactive power Q _f - reactive power by phases
$\varphi_s = \arctan2(P_t, Q_t)$ $\varphi_s = [-180^\circ, 179,99^\circ]$	Total power angle P _t - total active power S _t - total apparent power
$\text{PF}_t = \frac{P_t}{S_t}$	3 phase power factor P _t - phase active power S _t - phase apparent power
$\text{PF}_f = \frac{P_f}{S_f}$	Power factor by phases P _f - phase active power S _f - phase apparent power

THD

$$I_f\text{THD}(\%) = \frac{\sqrt{\sum_{n=2}^{63} I_n^2}}{I_1} 100$$

Current THD

I_1 - value of first harmonic
 n - number of harmonic

$$U_f\text{THD}(\%) = \frac{\sqrt{\sum_{n=2}^{63} U_{fn}^2}}{U_{f1}} 100$$

Phase voltage THD

U_1 - value of first harmonic
 n - number of harmonic

$$U_{ff}\text{THD}(\%) = \frac{\sqrt{\sum_{n=2}^{63} U_{ffn}^2}}{U_{ff1}} 100$$

Phase-to-phase voltage THD

U_1 - value of first harmonic
 n - number of harmonic



Iskra, d.o.o.
BU Ljubljana
 Stegne 21
 SI-1000, Ljubljana
 Phone: +386 1 513 10 00

Iskra, d.o.o.
BU Capacitors
 Vajdova ulica 71
 SI-8333, Semič
 Phone: +386 7 38 49 200

Iskra, d.o.o.
BU MIS
 Ljubljanska c. 24a
 SI-4000, Kranj
 Phone: +386 4 237 21 12

Iskra, d.o.o.
BU Batteries & Potentiometers
 Šentvid pri Stični 108
 SI-1296, Šentvid pri Stični
 Phone: +386 1 780 08 00

Iskra, d.o.o.
BU Electroplating
 Glinek 5
 SI-1291, Škofljica
 Phone: +386 1 366 80 50

Iskra IP, d.o.o.
 Vajdova ulica 71
 SI-8333, Semič
 Phone: +386 7 384 94 54

Iskra STIK, d.o.o.
 Ljubljanska cesta 24a
 SI-4000, Kranj
 Phone: +386 4 237 22 33

Iskra Lotrič, d.o.o.
 Ljubljanska c. 24a
 SI-4000, Kranj
 Phone: +386 4 237 21 12

Iskra ODM, d.o.o.
 Ljubljanska c. 24a
 SI-4000, Kranj
 Phone: +386 4 237 21 12

Iskra Tela L, d.o.o.
 Omladinska 66
 78250, Laktaši
 Phone: +387 51 535 890

Iskra Sistemi - M dooel
 Ul, Dame Gruev br. 16/5 kat
 1000, Skopje
 Phone: +389 75 444 498

Iskra Commerce, d.o.o.
 Hadži Nikole Živkoviča br. 2
 11000, Beograd
 Phone: +381 11 328 10 41

Iskra Hong Kong Ltd.
 33 Canton Road, T.S.T.
 1705, China HK City
 Phone: +852 273 00 917

ISKRA ELECTRONICS GmbH
 Südliche Münchner Str. 55
 82031 Grünwald
 Deutschland



Iskra, d.o.o.
 Stegne 21
 SI-1000 Ljubljana, Slovenia

Phone: +386 (0) 1 513 10 00
www.iskra.eu